

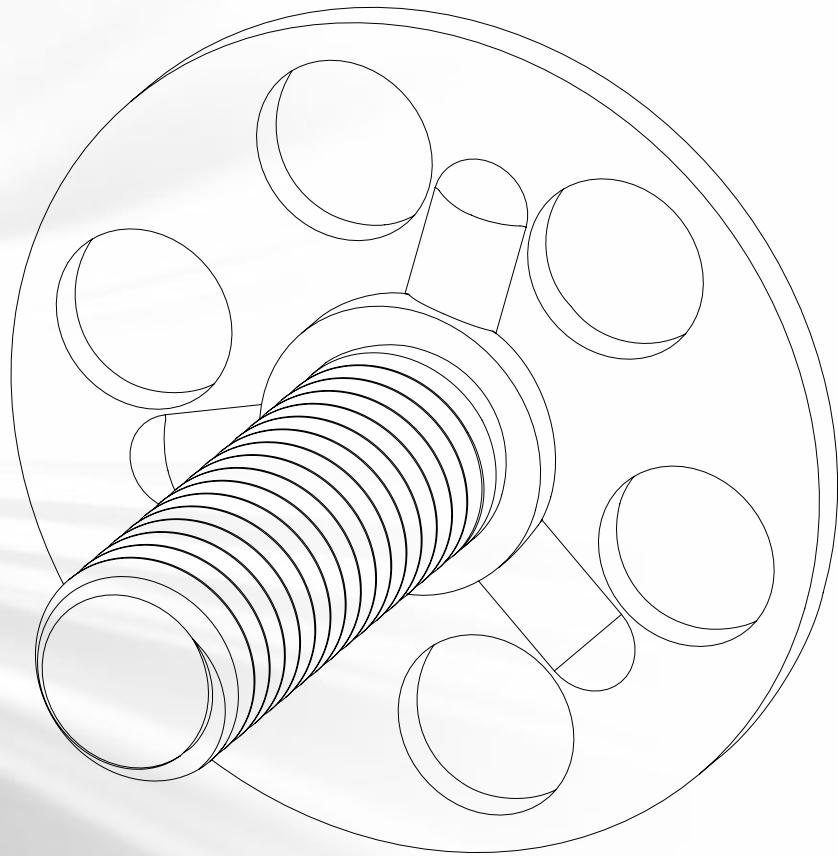

MASTER-PLATE®

FISSAGGI PER INCOLLAGGIO
BONDING FASTENERS



 **Chemical Concepts™**
Our expertise is your solution.

chemical-concepts.com
800.220.1966
410 Pike Road • Huntingdon Valley, PA 19006

PRODOTTI ITALIANI DA SEMPRE | ITALIAN MANUFACTURES SINCE EVER



OUR TRADITION IS TO INNOVATE.





Specialinsert® è un'azienda presente nel mondo dei sistemi di fissaggio dal 1974. Nasce per iniziativa di tre tecnici commerciali che, grazie alla loro esperienza nel settore dei fastener, decidono di avviarne la commercializzazione in proprio, affiancandole negli anni l'attività di fabbricazione.

Con tre unità locali, due depositi, due siti di produzione italiani, un ufficio R&S ed due laboratori prove, **Specialinsert®** è in grado di fornire ai clienti soluzioni sempre più avanzate e adatte ai diversi problemi di fissaggio.

Specialinsert® vanta una serie di proposte con soluzioni di fissaggio meccanico adatte a vari settori di applicazione: laminati tubolari metallici, componenti meccanici e plastici, legno, lapidei, nuovi materiali compositi e materiali innovativi quali solid surface, questi ultimi indicati particolarmente per applicazioni su arredi o edili.

Specialinsert® was established in 1974 by three sales agents who decided to exploit their experience in the fasteners industry to start up their own retail business. The company later developed and started its own production.

With three local branches, two warehouses, two production plants in Italy, an R&D office and two testing labs, **Specialinsert®** supplies cutting edge solutions suited to solving the most diverse fastening problems.

Specialinsert® offers a series of proposals with mechanical fixing solutions suitable for various application sectors such as: metal tubular laminates, mechanical and plastic components, wood, stone, new composite materials and innovative materials such as solid surface, the latter particularly suitable for applications on furniture or buildings.

PRODOTTI - PRODUCTS

LAMINATI SHEET METAL

Inseri per laminati,
profilati, tubolari
*Inserts for sheet metal,
section bars, tubes*



CORPI SOLIDI SOLID PARTS

Inseri per corpi solidi,
legno, metallo
*Inserts for solid, wood,
metal parts*



PLASTICA PLASTIC

Inseri per materie
plastiche
Inserts for plastic materials



COMPOSITI COMPOSITES

Inseri per materiali
compositi
*Inserts for composite
materials*



Nel costante impegno di migliorare i propri prodotti **Specialinsert®** si riserva il diritto di modificare le caratteristiche tecniche e costruttive senza preavviso: si invita a verificare eventuali aggiornamenti sulle schede tecniche pubblicate sul nostro sito www.specialinsert.it. Proprietà e diritti del documento sono riservati. Ne è vietata la riproduzione, anche parziale e la diffusione a terzi senza autorizzazione.

Specialinsert® is dedicated to the continuous improvement of its products and for this reason reserves the right to make any modifications to its technical or engineering specifications without notice: for the latest updates please refer to the technical data sheets published on our website www.specialinsert.it. This document is protected by copyright. None of its parts may be reproduced or transmitted to third parties without permission.

Specialinsert® è associata UNI, Ente Nazionale di Unificazione. Membro della Commissione Organi Meccanici.
Specialinsert® is UNI associated, National Unification Body. Member of the Mechanical Orders Commission.

Specialinsert® al fianco delle università per innovare. **Specialinsert®** alongside universities on innovations.



UNIVERSITÀ
DEL SALENTO



INDICE

Index

MASTER-PLATE® & MASTER-PLATE® RS p. 4

Guida alla scelta p. 5
Guide to choice

-
Gamma MASTER-PLATE® p. 10
MASTER-PLATE® range

-
Gamma MASTER-PLATE® RS p. 20
MASTER-PLATE® RS range

-
Accessori p. 30
Accessories

-
Prodotti speciali p. 32
Specials

MASTER-PLATE®



Caratteristiche
Features

Sistema composto da una BASE PIANA FORATA e da un elemento di fissaggio. Perni, boccole o dadi assemblati su un'ampia gamma di piastrine con forme e dimensioni diverse. Soluzioni passanti o cieche per tutte le esigenze. *System composed of a PERFORATED FLAT BASE and a fastener. Studs, bushes or nuts assembled on a wide range of plates with different shapes and dimensions. Through-hole or blind solutions are available for any kind of need.*

Vantaggi
Advantages

Ampia gamma, versatilità e adattabilità, veloce e facile da installare. *Wide range, versatility and adaptability, fast and easy to install.*

Montaggio
Assembly

Incollaggio, laminazione, stampaggio. *Bonding, rolling, molding.*

MASTER-PLATE® RS



Caratteristiche
Features

Sistema in grado di garantire uno spessore costante della colla, composto da una BASE CIECA con la presenza di DISTANZIALI TONDI (Round Spacers) e da un elemento di fissaggio Perni, boccole o dadi assemblati su un'ampia gamma di piastrine con forme e dimensioni diverse. Soluzioni passanti o cieche per tutte le esigenze. *System that guarantees an even adhesive thickness, composed of a BLIND BASE with ROUND SPACERS and a fastener. Studs, bushes or nuts assembled on a wide range of plates with different shapes and dimensions. Through-hole or blind solutions are available for any kind of need.*

Vantaggi
Advantages

Ampia gamma, versatilità e adattabilità, veloce e facile da installare, certezza dell'incollaggio, pulizia. *Wide range, versatility and adaptability, fast and easy to install. Even adhesive thickness, cleanliness.*

Montaggio
Assembly

Incollaggio.
Bonding.

GUIDA ALLA SCELTA

Guide to choice

Esigenze diverse comportano scelte diverse.
Different needs means different choices.

Specialinsert® è alla continua ricerca di soluzioni innovative in grado di migliorare i processi produttivi e rispondere alle esigenze del cliente. Per questo motivo è nata la nuova linea MASTER-PLATE® RS. Abbiamo sottoposto le due diverse tipologie di MASTER-PLATE® ad una serie di test comparativi per poter aiutare l'utilizzatore ad individuare il sistema di fissaggio più adatto alle proprie esigenze.

Specialinsert® is constantly looking for innovative solutions that can improve production processes and meet the needs of the customer. For this reason, the new MASTER-PLATE® RS range was born, and we have done a series of comparative tests on the two different types of MASTER-PLATE® in order to help the users identify the fastener system that best suits their needs.

Trazione - Pull out force

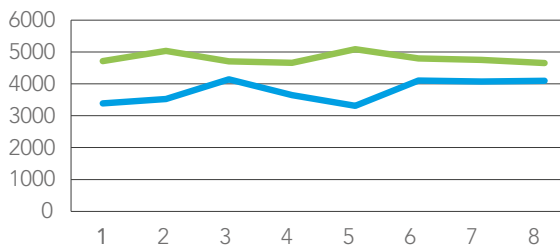

Master-Plate®

Valore Minimo Minimum Value	3312N (338Kg)
Valore Massimo Maximum Value	4145N (423Kg)
Delta Delta	833N (85Kg)
Valore Medio Average Value	3783N (386Kg)



Master-Plate® RS

Valore Minimo Minimum Value	4655N (475Kg)
Valore Massimo Maximum Value	5086N (519Kg)
Delta Delta	431N (44Kg)
Valore Medio Average Value	4802N (490Kg)

Taglio - Shear force

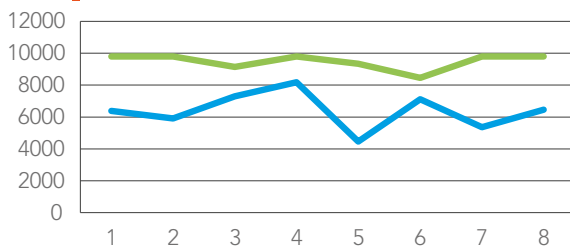

Master-Plate®

Valore Minimo Minimum Value	4469N (456Kg)
Valore Massimo Maximum Value	8183N (835Kg)
Delta Delta	3714N (379Kg)
Valore Medio Average Value	6390N (652Kg)



Master-Plate® RS

Valore Minimo Minimum Value	8457N (863Kg)
Valore Massimo Maximum Value	9807N (1000Kg)
Delta Delta	1342N (137Kg)
Valore Medio Average Value	9486N (968Kg)

Torsione - Torque

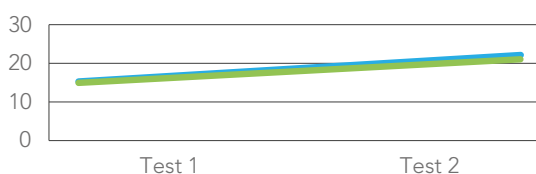

Master-Plate®

Valore Minimo Minimum Value	16,61N/m
Valore Massimo Maximum Value	20,63N/m
Delta Delta	4,02N/m



Master-Plate® RS

Valore Minimo Minimum Value	16,11N/m
Valore Massimo Maximum Value	19,67N/m
Delta Delta	3,56N/m

Test effettuati su piastrelle Q3232 con fissaggio perno M6 entrambi in acciaio inox 316 L. Gli esiti presentati in questo rapporto sono frutto di prove di laboratorio effettuate in condizioni ottimali non ripetibili; pertanto i dati risultanti sono da intendere come indicativi e non vincolanti. Tests carried out on Q3232 plates with stud M6 fixing, both products were in stainless steel 316 L. The results presented in this report are the result of laboratory tests carried out under optimal conditions that cannot be repeated; therefore, the resulting data is intended as indicative and non-binding.

Impiego di collante

Adhesive consumption

MASTER-PLATE®

La distribuzione del collante interessa l'intera superficie della piastrina. Si consiglia un'applicazione «a serpentina» in modo da creare uno strato costante e continuo. L'eventuale eccedenza trafila attraverso i fori della base.

Adhesive is applied on the entire surface of the plate. We recommend a "serpentine" application to create a constant and continuous layer. Any excess gets out through the holes of the base.



MASTER-PLATE® RS

Il collante è applicato al centro della base. Esercitando una leggera pressione in fase di posa questo si distribuisce uniformemente su tutta la superficie. I distanziali che caratterizzano la piastrina fungono da punto d'arresto.

Adhesive is applied at the center of the base. By exerting a slight pressure during the lying phase, it is evenly distributed over the entire surface. The Round Spacers characterizing the plate act as a stopping point.

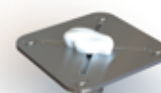

	Q.tà media di Collante Utilizzato Average quantity of adhesive used	Numero medio di incollaggi per cartuccia (50 ml) Average number of pasted pieces per cartridge (50ml)	Δ% di collante utilizzata rispetto alla Versione Standard Δ% of adhesive used vs MASTER-PLATE® Standard Version	Costo Indicativo del singolo incollaggio* Average cost of single gluing*
MASTER-PLATE®	2,32 gr	21 pz.	-	0,38 €/pc
MASTER-PLATE® RS	0,65 gr	75 pz.	-72 %	0,10 €/pc

* Considerato un costo di € 8,00 per cartuccia 50 ml
* When price of 50ml adhesive cartridge is € 8.00

Interferenze e mantenimento assialità

Interferences and axiality maintenance

MASTER-PLATE®

L'eccedenza del collante, fuoriuscendo dai fori della base, crea un'interferenza. Non è per ciò possibile avvitare un componente al MASTER-PLATE® sino al limite inferiore della parte filettata. È altrettanto critico, mantenere l'assialità tra le parti, tali interferenze variano in funzione della quantità di collante applicato.

Mediamente si rileva un ingombro compreso tra 3 e 5 mm.

The excess of adhesive, coming out of the holes of the base, creates interference. Therefore, it is not possible to screw a component to MASTER-PLATE® until the lower bound of the threaded part. It is equally critical to maintain axiality between the parties. Such interferences vary depending on the amount of adhesive applied. On average, there is a footprint between 3 and 5mm.



MASTER-PLATE® RS

Non si evidenzia alcuna interferenza. Il collante non si interpone tra il MASTER-PLATE® e l'elemento avvitato adesso. La parte filettata è completamente libera e sfruttabile. Non si riscontrano problemi di assialità.

No interference is remarked. The adhesive does not interpose between the MASTER-PLATE® and the element screwed to it. The threaded part is completely free and usable. There are no axiality problems.



Conclusioni

Conclusions

Tutta la gamma MASTER-PLATE® sottoposta ai test ha ottenuto ottime prestazioni. Pur mantenendo la stessa filosofia, le due tipologie di MASTER-PLATE® ottengono performance diverse a seconda dei diversi criteri di valutazione.

L'orientamento nella scelta della Serie dipende da fattori diversi, quali:

- Resistenza alla Trazione
- Resistenza al Taglio
- Resistenza alla Torsione
- Risparmio di Colla
- Peso del sistema di fissaggio completo
- Qualità dell'incollaggio (presenza di interferenze e mantenimento dell'assialità)

Per le performance legate alle due tipologie Master-Plate fare riferimento al grafico qui sotto:

The whole MASTER-PLATE® range performed very well during tests, and the two different types of MASTER-PLATE® perform differently, depending on the different evaluation criteria.

The choice amongst the Series products depends on different factors, such as:

- Pull Out Force Resistance
- Shear Force Resistance
- Torque Resistance
- Adhesive Saving
- Weight Saving
- Gluing quality (interferences and maintaining axiality)

For details on the performances related to the two Master-Plate versions mentioned, see the graph below:

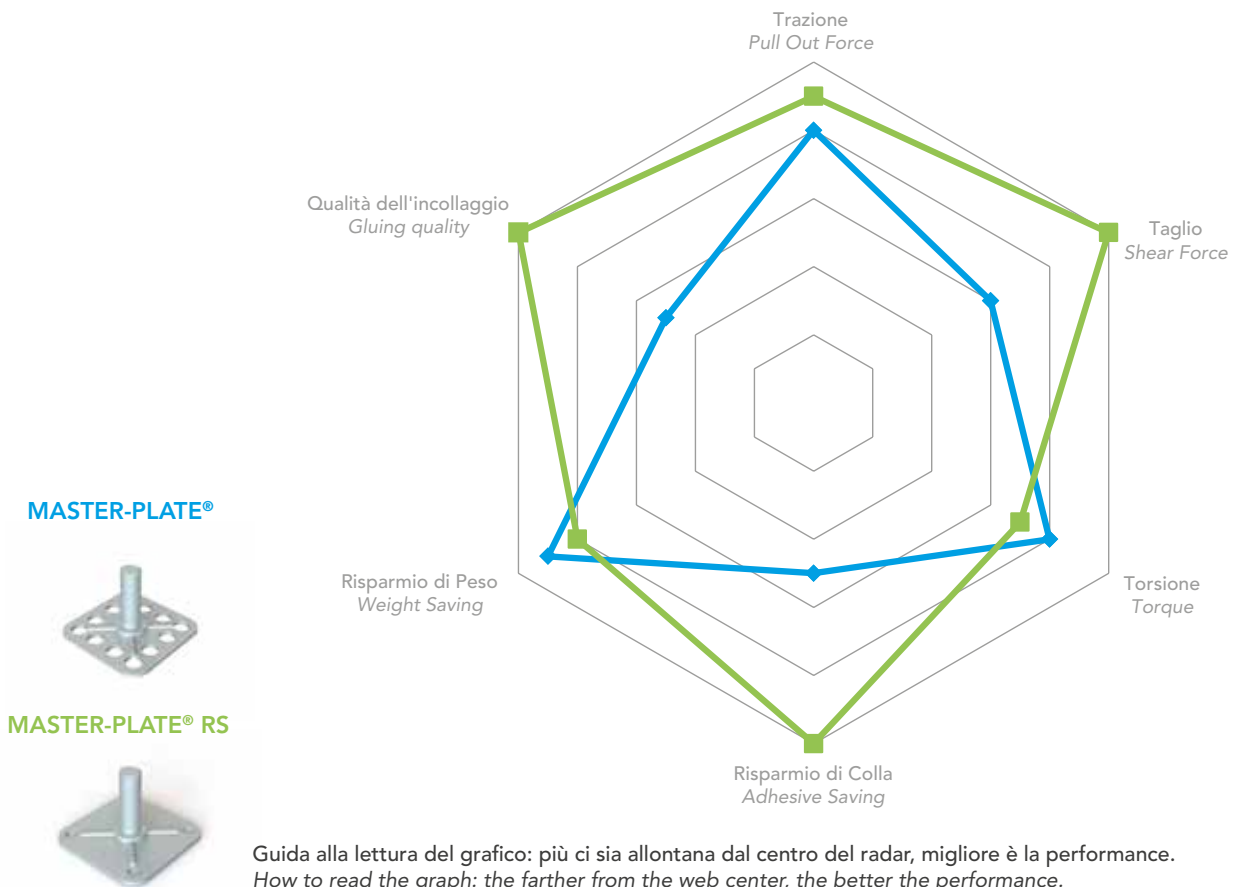

COMPOSIZIONE DEL CODICE

Steps for creating the reference code

STEP 1

Tipo di ancoraggio
Type of anchorage

PR

SERIE/SERIES

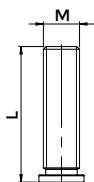

PRS

SERIE/SERIES

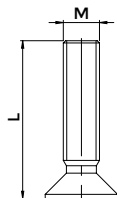

BR_

SERIE/SERIES

P Piastrina Passante
Through Hole Plate
C Piastrina Cieca
Blind Hole Plate

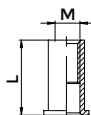

DF_

SERIE/SERIES

P Piastrina Passante
Through Hole Plate
C Piastrina Cieca
Blind Hole Plate

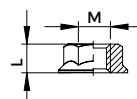

DR_

SERIE/SERIES

P Piastrina Passante
Through Hole Plate
C Piastrina Cieca
Blind Hole Plate

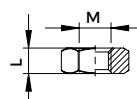

STEP 2

Lunghezze perno (L)
Stud length (L)

10
12
16
20
25
30
40

Lunghezze perno (L)
Stud length (L)

45
50
60
70
80
90
100

Altezze boccola (L)
Bush height (L)

05
10
12
15
20
22
25

Altezze dado (L)
Nut height (L)

04 = M4x4,3
05 = M5x4,8
06 = M6x5,4

Altezze dado (L)
Nut height (L)

03 = M4x3,2
04 = M5x4,0
05 = M6x5,0
06 = M8x6,5
08 = M10x8,0

STEP 3

Tipo piastrina
Plate type



T1900
Ø19 mm



T2000
Ø20 mm



T2300
Ø23 mm

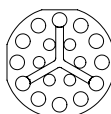

T3800
Ø38 mm



Q1515
15x15 mm

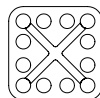

Q3232
32x32 mm



R3815
38x15 mm

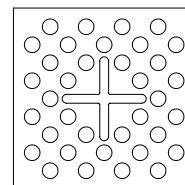

Q5858
58x58 mm

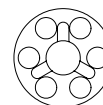

Esempio di piastrina passante
Example of through hole plate
Q1515 non passante
Q1515 no through hole

STEP 4

Filetto (M)
Thread (M)

040 M4
050 M5
060 M6
080 M8

050 M5
060 M6
080 M8
100 M10

040 M4
050 M5
060 M6
080 M8
100 M10

040 M4
050 M5
060 M6

080 M8
100 M10

STEP 5

Materiale
Material

Acciaio Zincato
Acciaio Inox 316 allo stato naturale
Acciaio Inox 316 Elettrolucidato

.12 Zinc Plated Steel
.51 316 Stainless Steel in its natural state
.56 Electropolished 316 Stainless Steel

.12
.51
.56

Esempio di designazione - Example of code designation

Boccola filettata con piastrina cieca tonda T3800, filettatura M6, altezza 12 mm, in acciaio zincato.
Threaded bush with T3800 round blind plate, M6 thread, 12mm height, zinc-plated steel.

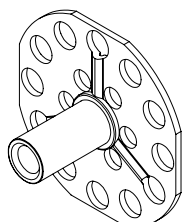

BRC 12 T3800 060. 12

STEP 1

STEP 2

STEP 3

STEP 4

STEP 5

NOTA BENE: per conoscere le disponibilità e la fattibilità dei prodotti, contattare l'ufficio tecnico/commerciale Specialinsert® oppure consultare le schede tecniche scaricabili dal nostro sito www.specialinsert.it
NOTA BENE: For more information regarding product availability and feasibility, please contact the Specialinsert® tech/sales office or refer to the technical sheets downloadable at www.specialinsert.it

Le dimensioni sono indicative, non vincolanti, espresse in mm - Dimensions are indicative and not binding, expressed in mm

MONTAGGIO

Installation



1
 Predisporre la superficie idonea all'incollaggio
 Prepare the surface for receiving the adhesive



2
 Depositare sul MASTER-PLATE® l'apposito collante
 Place the proper adhesive on MASTER-PLATE®



3
 Posizionare il MASTER-PLATE® sulla superficie
 Place MASTER-PLATE® on the surface



4
 Premere MASTER-PLATE® fino alla fuoriuscita del collante dai fori della base
 Press the MASTER-PLATE® in order to have some adhesive coming out from the holes of the base plate



5
 Attendere l'indurimento del collante prima di utilizzare il fissaggio
 Wait for the adhesive to harden before using the fastening system



6
 MASTER-PLATE® ora è fissata strutturalmente ed assemblata
 MASTER-PLATE® is structurally assembled and ready for use

SUGGERIMENTI PER LA SCELTA DELLE COLLE

Adhesives suggestions

La tabella sottostante fornisce alcune indicazioni di massima sulle possibilità di utilizzo del collante. Per ottenere un corretto impiego del prodotto si consiglia di effettuare prove di incollaggio.

The table below gives some overall indications about several uses of the adhesive and materials. To get a correct use of the product, we advise you to perform bonding tests.

Tipo Colla Adhesive type	Compositi Composites	Plastica(*) Plastic(*)	Legno Wood	Metallo Metal	Lapidei Natural Stone	Agglomerati Conglomerated	Cristalli Glass
MASTIKOL SG 300-15	○ ○ (**)	○ ○	-	○ ○ (**)	○	○ ○	○
VABER MA300	○ ○	○ ○	○	○ ○	○	○ ○	○ ○
3M DP8810NS	○ ○	○	○	○ ○	○	○	-
LOCTITE 9466	○ ○	○	○ ○	○ ○	○ ○	○ ○	○ ○

LEGENDA: - Non adatto ○ Sufficiente ○ ○ Buono
 KEY: - Not suitable ○ Sufficient ○ ○ Good

(*) Adesivi idonei ad alta energia superficiale di facile incollaggio.
 (*) Adhesives suitable for high surface energy of easy bonding.

Su plastiche a bassa energia superficiale e quindi di scarsa adesione si consigliano le seguenti colle: 3M DP8010, MASTIKOL PPX5.
 On plastics with low surface energy, therefore with low adhesion properties, we recommend: 3M DP8010, MASTIKOL PPX5.

Per la corretta definizione dell'adesivo da utilizzare, su materiali con poca tenuta quali PE, PA, PP e silicone raccomandiamo di interpellare direttamente i produttori delle colle.
 For the correct definition of the adhesive to be used on materials with little holding features, such as PE, PA, PP and silicone, we recommend to contact the glue manufacturers.

(**) Non necessita l'uso di primer o abrasione.

(**) Primer or abrasion not needed.

STEP 1 PR SERIE/SERIES

Perno filettato con piastrina
Threaded stud with plate



STEP 2 Lunghezze perno (L)
Stud length (L) 10* - 12 - 16 - 20 - 25 - 30 - 40
* Non disponibile nella versione inox 316
* 316 Stainless Steel not available
Per lunghezza perno oltre 40 mm consultare la scheda PRS
For stud length over 40mm, see PRS technical sheet

STEP 3 Tipo piastrina
Plate type

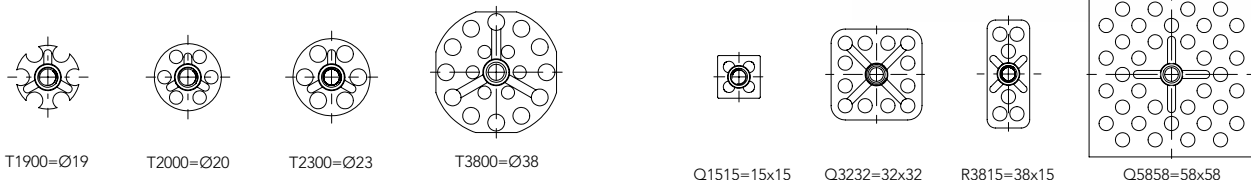

STEP 4 Filetto (M)
Thread (M) M4 - M5 - M6 - M8
Tolleranza 6g / Tolerance 6g
Per filetto M10 consultare la scheda PRS (lunghezza min. a catalogo 45 mm)
For M10 thread, see PRS data sheet (catalogue products min. length 45mm)

STEP 5 Materiale
Material Acciaio Zincato .12 Zinc Plated Steel .12
Acciaio Inox 316 .51 316 Stainless Steel .51

CODICE CODE	d1 Filetto Thread	d2 Acciaio .12 Steel .12	d2 Inox .51 Stainless Steel .51	CODICE CODE	d1 Filetto Thread	d2 Acciaio .12 Steel .12	d2 inox .51 Stainless Steel .51
PR_T1900040._				PR_Q1515040._			
PR_T2000040._	M 4	5,5	8,5	PR_Q3232040._	M 4	5,5	8,5
PR_T2300040._				PR_R3815040._			
PR_T3800040._				PR_Q5858040._			
PR_T1900050._				PR_Q1515050._			
PR_T2000050._	M 5	6,5	9,8	PR_Q3232050._	M 5	6,5	9,8
PR_T2300050._				PR_R3815050._			
PR_T3800050._				PR_Q5858050._			
PR_T1900060._				PR_Q1515060._			
PR_T2000060._	M 6	7,5	9,8	PR_Q3232060._	M 6	7,5	9,8
PR_T2300060._				PR_R3815060._			
PR_T3800060._				PR_Q5858060._			
PR_T1900080._				PR_Q1515080._			
PR_T2000080._	M 8	10,0	11,5	PR_Q3232080._	M 8	10,0	11,5
PR_T2300080._				PR_R3815080._			
PR_T3800080._				PR_Q5858080._			

Le dimensioni sono indicative, non vincolanti, espresse in mm – Dimensions are indicative and not binding, expressed in mm

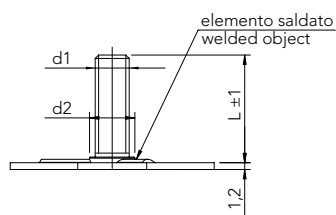

PR 20 R3815 060. 12

STEP 1 **STEP 2** **STEP 3** **STEP 4** **STEP 5**

Esempio di designazione: Perno filettato con piastrina rettangolare R3815, filettatura M6, lunghezza 20 mm, in acciaio zincato:
Example of code designation: Threaded stud with R3815 rectangular plate, M6 thread, 20mm length, zinc-plated steel

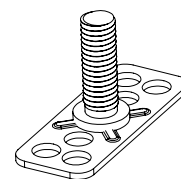

PR20R3815060.12

NOTA BENE: per conoscere le disponibilità e la fattibilità dei prodotti, contattare l'ufficio tecnico/commerciale Specialinsert® oppure consultare le schede tecniche scaricabili dal nostro sito www.specialinsert.it
NOTA BENE: for more information regarding product availability and feasibility, please contact the Specialinsert® tech/sales office or refer to the technical sheets downloadable at www.specialinsert.it

STEP 1 PRS SERIE/SERIES

Perno filettato con testa svasata con piastrina
Threaded stud with countersunk head and plate

STEP 2 Lunghezza perno (L) 45 - 50 - 60 - 70 - 80 - 90 - 100

Stud length (L)

Per lunghezza perno inferiore a mm 45 consultare la scheda PR (esclusa filettatura M10)
For stud length under 45mm, see PR technical sheet (not including M10 thread)



STEP 3 Tipo piastrina
Plate type

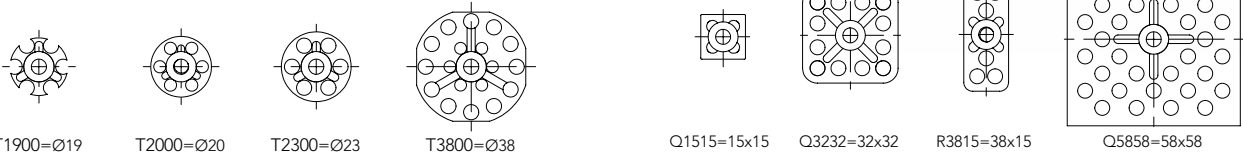

STEP 4 Filetto (M) M5 - M6 - M8 - M10
Thread (M) Tolleranza 6g / Tolerance 6g

STEP 5 Materiale Acciaio Zincato .12 Zinc Plated Steel .12
Material Acciaio Inox 316 .51 316 Stainless Steel .51

CODICE CODE	d1 Filetto Thread	d2 (max)	K +0,5 0	CODICE CODE	d1 Filetto Thread	d2 (max)	K +0,5 0
PRS_T1900050._	M 5	10	2,8	PRS_Q1515050._	M 5	10	2,8
PRS_T2000050._				PRS_Q3232050._			
PRS_T2300050._				PRS_R3815050._			
PRS_T3800050._				PRS_Q5858050._			
PRS_T1900060._	M 6	12	3,3	PRS_Q1515060._	M 6	12	3,3
PRS_T2000060._				PRS_Q3232060._			
PRS_T2300060._				PRS_R3815060._			
PRS_T3800060._				PRS_Q5858060._			
PRS_T2000080._	M 8	16	4,4	PRS_Q3232080._	M 8	16	4,4
PRS_T2300080._				PRS_Q5858080._			
PRS_T3800080._				PRS_Q3232100._			
PRS_T3800100._				PRS_Q5858100._			

Le dimensioni sono indicative, non vincolanti, espresse in mm - Dimensions are indicative and not binding, expressed in mm

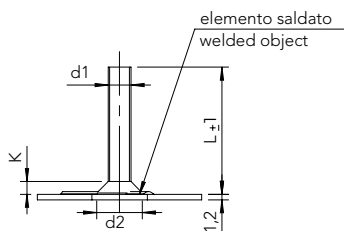

PRS 60 R3815 060. 12

STEP 1 STEP 2 STEP 3 STEP 4 STEP 5

Esempio di designazione: Perno filettato con piastrina rettangolare R3815, filettatura M6, lunghezza 60 mm, in acciaio zincato
Example of code designation: Threaded stud with R3815 rectangular plate, M6 thread, 20mm length, zinc-plated steel

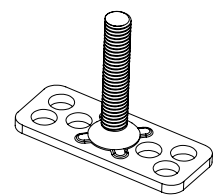

PRS60R3815060.12

NOTA BENE: per conoscere le disponibilità e la fattibilità dei prodotti, contattare l'ufficio tecnico/commerciale Specialinsert® oppure consultare le schede tecniche scaricabili dal nostro sito www.specialinsert.it
NOTA BENE: for more information regarding product availability and feasibility, please contact the Specialinsert® tech/sales office or refer to the technical sheets downloadable at www.specialinsert.it

STEP 1 **BRC** SERIE/SERIES

Boccola filettata con piastrina cieca
Threaded bush with blind plate



STEP 2 Altezze boccola (L) 5 - 10 - 12 - 15 - 20 - 22 - 25
Bush height (L)

STEP 3 Tipo piastrina
Plate type

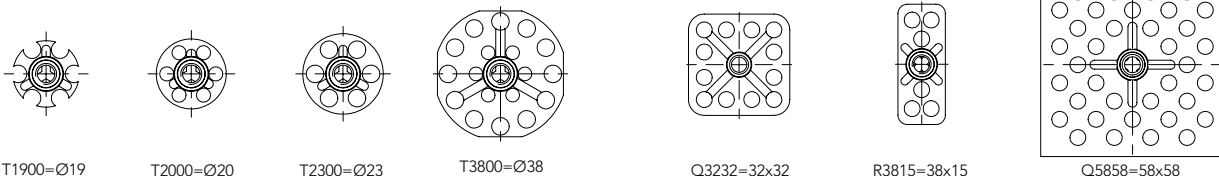

STEP 4 Filetto (M) M4 - M5 - M6 - M8 - M10
Thread (M) Tolleranza 6H / Tolerance 6H

STEP 5 Materiale Acciaio Zincato .12 Zinc Plated Steel .12
Material Acciaio Inox 316 .51 316 Stainless Steel .51

CODICE CODE	d1 Filetto Thread	d2	d3	CODICE CODE	d1 Filetto Thread	d2	d3
BRC_T1900040._	M 4	12	8,3	BRC_Q3232040._	M 4	12	8,3
BRC_T2000040._				BRC_R3815040._			
BRC_T2300040._				BRC_Q5858040._			
BRC_T3800040._	M 5	13	9,6	BRC_Q3232050._	M 5	13	9,6
BRC_T1900050._				BRC_R3815050._			
BRC_T2000050._				BRC_Q5858050._			
BRC_T2300050._	M 6	13	9,6	BRC_Q3232060._	M 6	13	9,6
BRC_T3800050._				BRC_R3815060._			
BRC_T1900060._				BRC_Q5858060._			
BRC_T2000060._	M 8	15	11,0	BRC_Q3232080._	M 8	15	11,0
BRC_T2300060._				BRC_R3815080._			
BRC_T3800060._				BRC_Q5858080._			
BRC_T2300080._	M 10	16	12,6	BRC_Q3232100._	M 10	16	12,6
BRC_T3800080._				BRC_R3815100._			
BRC_T2300100._				BRC_Q5858100._			
BRC_T3800100._							

N.B: L1= tratto utile filetto (max 3 volte ø) / NB L1= threaded length (max 3 times ø)
Le dimensioni sono indicative, non vincolanti, espresse in mm - Non binding dimensions, expressed in mm

BRC 15 R3815 060. 12

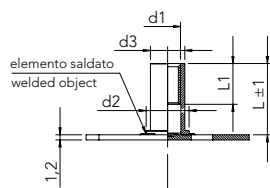

STEP 1 STEP 2 STEP 3 STEP 4 STEP 5

Esempio di designazione: Boccola filettata con piastrina cieca rettangolare R3815, filettatura M6, altezza 15 mm, in acciaio zincato
Example of code designation: Threaded bush with R3815 rectangular blind plate, M6 thread, 15mm length, zinc-plated steel

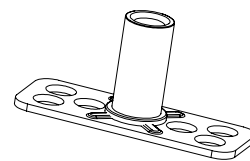

BRC15R3815060.12

NOTA BENE: per conoscere le disponibilità e la fattibilità dei prodotti, contattare l'ufficio tecnico/commerciale Specialinsert® oppure consultare le schede tecniche scaricabili dal nostro sito www.specialinsert.it
NOTA BENE: for more information regarding product availability and feasibility, please contact the Specialinsert® tech/sales office or refer to the technical sheets downloadable at www.specialinsert.it

STEP 1 **BRP SERIE/SERIES**

Boccola filettata con piastrina passante
Threaded bush with through-hole plate



STEP 2 Altezze boccola (L) 5 - 10 - 12 - 15 - 20 - 22 - 25
Bush height (L)

STEP 3 Tipo piastrina
Plate type

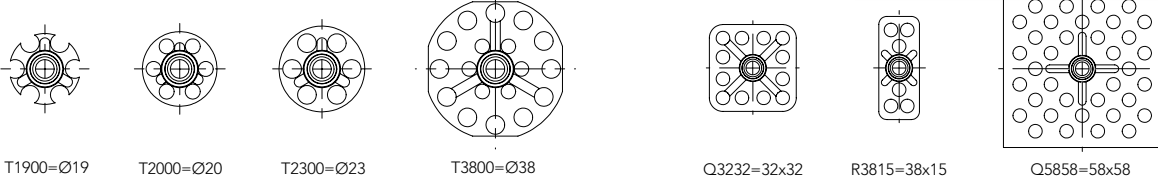

STEP 4 Filetto (M) M4 - M5 - M6 - M8 - M10
Thread (M) Tolleranza 6H / Tolerance 6H

STEP 5 Materiale Acciaio Zincato .12 Zinc Plated Steel .12
Material Acciaio Inox 316 .51 316 Stainless Steel .51

CODICE CODE	d1 Filetto Thread	d2	d3	CODICE CODE	d1 Filetto Thread	d2	d3
BRP_T1900040._	M 4	12	8,3	BRP_Q3232040._	M 4	12	8,3
BRP_T2000040._				BRP_R3815040._			
BRP_T2300040._				BRP_Q5858040._			
BRP_T3800040._				BRP_Q3232050._			
BRP_T1900050._	M 5	13	9,6	BRP_R3815050._	M 5	13	9,6
BRP_T2000050._				BRP_Q5858050._			
BRP_T2300050._				BRP_Q3232060._			
BRP_T3800050._				BRP_R3815060._			
BRP_T1900060._	M 6	13	9,6	BRP_Q5858060._	M 6	13	9,6
BRP_T2000060._				BRP_Q3232080._			
BRP_T2300060._				BRP_R3815080._			
BRP_T3800060._				BRP_Q5858080._			
BRP_T2300080._	M 8	15	11,0	BRP_Q3232100._	M 8	15	11,0
BRP_T3800080._				BRP_R3815100._			
BRP_T2300100._				BRP_Q5858100._			
BRP_T3800100._							

N.B: L1= tratto utile filetto (max 3 volte ø) / NB L1= threaded length (max 3 times ø)
Le dimensioni sono indicative, non vincolanti, espresse in mm - Dimensions are indicative and not binding, expressed in mm

BRP 15 R3815 060. 12

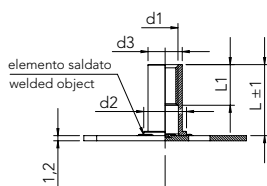

STEP 1 STEP 2 STEP 3 STEP 4 STEP 5

Esempio di designazione: Boccola filettata con piastrina passante rettangolare R3815, filettatura M6, altezza 15 mm, in acciaio zincato
Example of code designation: Threaded bush with R3815 rectangular through-hole plate, M6 thread, 15mm length, zinc-plated steel

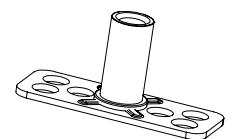

BRP15R3815060.12

NOTA BENE: per conoscere le disponibilità e la fattibilità dei prodotti, contattare l'ufficio tecnico/commerciale Specialinsert® oppure consultare le schede tecniche scaricabili dal nostro sito www.specialinsert.it
NOTA BENE: for more information regarding product availability and feasibility, please contact the Specialinsert® tech/sales office or refer to the technical sheets downloadable at www.specialinsert.it

STEP 1 **DFC** SERIE/SERIES

Dado flangiato con piastrina cieca
Flanged nut with blind plate



STEP 2 Altezze dado (L) 04 = M4x4,3
Nut height (L) 05 = M5x4,8
06 = M6x5,4

STEP 3 Tipo piastrina
Plate type

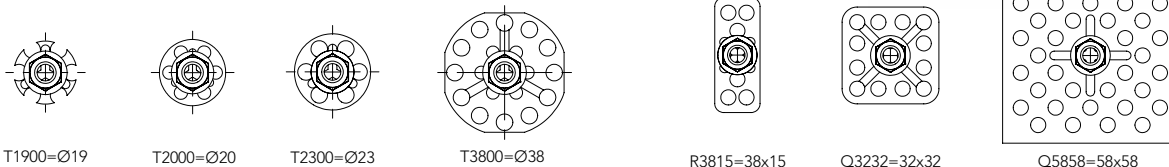

STEP 4 Filetto (M) M4 - M5 - M6
Thread (M) Tolleranza 6H / Tolerance 6H

STEP 5 Materiale Acciaio Zincato .12 Zinc Plated Steel .12
Material Acciaio Inox 316 .51 316 Stainless Steel .51

CODICE CODE	d1 Filetto Thread	Chiave esagono Hex Key	e	d2	L	CODICE CODE	d1 Filetto Thread	Chiave esagono Hex Key	e	d2	L
DFC04T1900040._						DFC04R3815040._					
DFC04T2000040._	M 4	7	7,8	9,10	4,3	DFC04Q3232040._	M 4	7	7,8	9,10	4,3
DFC04T2300040._						DFC04Q5858040._					
DFC04T3800040._						DFC05R3815050._					
DFC05T1900050._						DFC05Q3232050._	M 5	8	8,9	10,50	4,8
DFC05T2000050._	M 5	8	8,9	10,50	4,8	DFC05Q5858050._					
DFC05T2300050._						DFC06R3815060._					
DFC05T3800050._						DFC06Q3232060._	M 6	10	11,1	12,95	5,4
DFC06T1900060._						DFC06Q5858060._					
DFC06T2000060._	M 6	10	11,1	12,95	5,4						
DFC06T2300060._											
DFC06T3800060._											

Le dimensioni sono indicative, non vincolanti, espresse in mm - Dimensions are indicative and not binding, expressed in mm

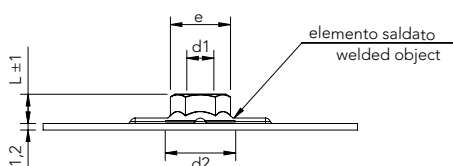

DFC 06 R3815 060. 12

STEP 1 **STEP 2** **STEP 3** **STEP 4** **STEP 5**

Esempio di designazione: Dado filettato flangiato con piastrina cieca rettangolare R3815, filettatura M6, altezza 5,4 mm, in acciaio zincato
Example of code designation: Flanged threaded nut with R3815 rectangular blind plate, M6 thread, 5,4mm height, zinc-plated steel

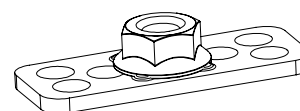

DFC06R3815060.12

NOTA BENE: per conoscere le disponibilità e la fattibilità dei prodotti, contattare l'ufficio tecnico/commerciale Specialinsert® oppure consultare le schede tecniche scaricabili dal nostro sito www.specialinsert.it
NOTA BENE: for more information regarding product availability and feasibility, please contact the Specialinsert® tech/sales office or refer to the technical sheets downloadable at www.specialinsert.it

STEP 1 **DFP** SERIE/SERIES

Dado flangiato con piastrina passante
Flanged nut with through-hole plate



STEP 2 Altezze dado (L) 04 = M4x4,3
Nut height (L) 05 = M5x4,8
06 = M6x5,4

STEP 3 Tipo piastrina
Plate type



STEP 4 Filetto (M) M4 - M5 - M6
Thread (M) Tolleranza 6H / Tolerance 6H

STEP 5 Materiale Acciaio Zincato .12 Zinc Plated Steel .12
Material Acciaio Inox 316 .51 316 Stainless Steel .51

CODICE CODE	d1 Filetto Thread	Chiave esagono Hex Key	d2	e	L	CODICE CODE	d1 Filetto Thread	Chiave esagono Hex Key	d2	e	L
DFP04T1900040._						DFP04R3815040._					
DFP04T2000040._	M 4	7	9,10	7,8	4,3	DFP04Q3232040._	M 4	7	9,10	7,8	4,3
DFP04T2300040._						DFP04Q5858040._					
DFP04T3800040._						DFP05R3815050._					
DFP05T1900050._						DFP05Q3232050._	M 5	8	10,50	8,9	4,8
DFP05T2000050._	M 5	8	10,50	8,9	4,8	DFP05Q5858050._					
DFP05T2300050._						DFP06R3815060._					
DFP05T3800050._						DFP06Q3232060._	M 6	10	12,95	11,1	5,4
DFP06T1900060._						DFP06Q5858060._					
DFP06T2000060._	M 6	10	12,95	11,1	5,4						
DFP06T2300060._											
DFP06T3800060._											

Le dimensioni sono indicative, non vincolanti, espresse in mm – Dimensions are indicative and not binding, expressed in mm

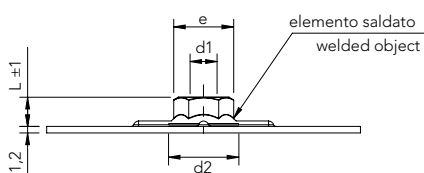

DFP 06 R3815 060. 12

STEP 1 **STEP 2** **STEP 3** **STEP 4** **STEP 5**

Esempio di designazione: Dado filettato flangiato con piastrina passante rettangolare R3815, filettatura M6, altezza 5,4 mm, in acciaio zincato
Example of code designation: Flanged threaded nut with R3815 rectangular through-hole plate, M6 thread, 5,4mm height, zinc-plated steel

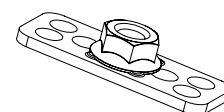

DFP06R3815060.12

NOTA BENE: per conoscere le disponibilità e la fattibilità dei prodotti, contattare l'ufficio tecnico/commerciale Specialinsert® oppure consultare le schede tecniche scaricabili dal nostro sito www.specialinsert.it
NOTA BENE: for more information regarding product availability and feasibility, please contact the Specialinsert® tech/sales office or refer to the technical sheets downloadable at www.specialinsert.it

STEP 1 **DRC** SERIE/SERIES

Dado con piastrina cieca
Nut with blind plate



STEP 2 Altezze dado (L)
Nut height (L)

03 = M4x3,2	06 = M8x6,5
04 = M5x4,0	08 = M10x8,0
05 = M6x5,0	

STEP 3 Tipo piastrina
Plate type

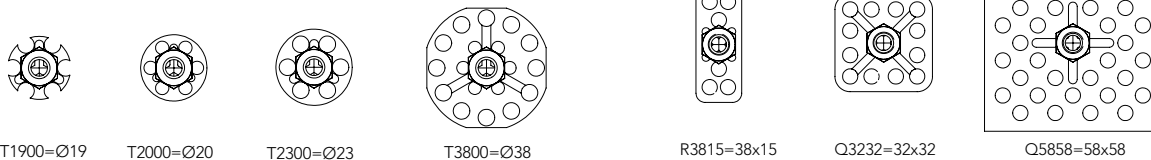

STEP 4 Filetto (M)
Thread (M)

M4 - M5 - M6 - M8 - M10
Tolleranza 6H / Tolerance 6H

Per le filettature M4, M5 e M6 vedere articoli standard su scheda DFC
For M4, M5 and M6 threads, see standard products on DFC technical sheet

STEP 5 Materiale
Material

Acciaio Zincato	.12	Zinc Plated Steel	.12
Acciaio Inox 316	.51	316 Stainless Steel	.51

CODICE CODE	d1 Filetto Thread	Chiave esagono Hex Key	e	L	CODICE CODE	d1 Filetto Thread	Chiave esagono Hex Key	e	L
DRC03T1900040._	M 4	7	7,8	3,2	DRC03R3815040._	M 4	7	7,8	3,2
DRC03T2000040._					DRC03Q3232040._				
DRC03T2300040._					DRC03Q5858040._				
DRC03T3800040._					DRC04R3815050._				
DRC04T1900050._	M 5	8	8,9	4,0	DRC04Q3232050._	M 5	8	8,9	4,0
DRC04T2000050._					DRC04Q5858050._				
DRC04T2300050._					DRC05R3815060._				
DRC04T3800050._					DRC05Q3232060._				
DRC05T1900060._	M 6	10	11,1	5,0	DRC05Q5858060._	M 6	10	11,1	5,0
DRC05T2000060._					DRC06R3815080._				
DRC05T2300060._					DRC06Q3232080._				
DRC05T3800060._					DRC06Q5858080._				
DRC06T1900080._	M 8	13	14,4	6,5	DRC08R3815100._	M 8	13	14,4	6,5
DRC06T2000080._					DRC08Q3232100._				
DRC06T2300080._					DRC08Q5858100._				
DRC06T3800080._									
DRC08T2000100._	M 10	17	19,0	8,0		M 10	17	19,0	8,0
DRC08T2300100._									
DRC08T3800100._									

Le dimensioni sono indicative, non vincolanti, espresse in mm - Dimensions are indicative and not binding, expressed in mm

DRC 04 Q3232 050. 12

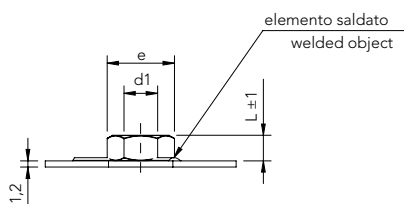

STEP 1 **STEP 2** **STEP 3** **STEP 4** **STEP 5**

Esempio di designazione: Dado filettato con piastrina cieca quadrata Q3232, filettatura M5, altezza 4 mm, in acciaio zincato
Example of code designation: Threaded nut with Q3232 square blind plate, M5 thread, 4mm height, zinc-plated steel

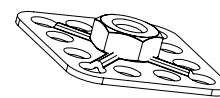

DRC04Q3232050.12

NOTA BENE: per conoscere le disponibilità e la fattibilità dei prodotti, contattare l'ufficio tecnico/commerciale Specialinsert® oppure consultare le schede tecniche scaricabili dal nostro sito www.specialinsert.it
NOTA BENE: for more information regarding product availability and feasibility, please contact the Specialinsert® tech/sales office or refer to the technical sheets downloadable at www.specialinsert.it

STEP 1 **DRP** SERIE/SERIES

Dado con piastrina passante
Nut with through-hole plate



STEP 2

Altezze dado (L) Nut height (L)	03 = M4x3,2 04 = M5x4,0 05 = M6x5,0	06 = M8x6,5 08 = M10x8,0
---	---	-----------------------------

STEP 3

Tipo piastrina Plate type							
	T1900=Ø19	T2000=Ø20	T2300=Ø23	T3800=Ø38	R3815=38x15	Q3232=32x32	Q5858=58x58

STEP 4

Filetto (M) Thread (M)	M4 - M5 - M6 - M8 - M10 Tolleranza 6H / Tolerance 6H Per le filettature M4, M5 e M6 vedere articoli standard su scheda DFP For M4, M5 and M6 threads, see standard products on DFP technical sheet
----------------------------------	---

STEP 5

Materiale Material	Acciaio Zincato Zinc Plated Steel	.12	.12
	Acciaio Inox 316 316 Stainless Steel	.51	.51

CODICE CODE	d1 Filetto Thread	Chiave esagono Hex Key	e	L	CODICE CODE	d1 Filetto Thread	Chiave esagono Hex Key	e	L
DRP03T1900040._					DRP03R3815040._				
DRP03T2000040._	M 4	7	7,8	3,2	DRP03Q3232040._	M 4	7	7,8	3,2
DRP03T2300040._					DRP03Q5858040._				
DRP03T3800040._					DRP04R3815050._				
DRP04T1900050._					DRP04Q3232050._	M 5	8	8,9	4,0
DRP04T2000050._	M 5	8	8,9	4,0	DRP04Q5858050._				
DRP04T2300050._					DRP05R3815060._				
DRP04T3800050._					DRP05Q3232060._	M 6	10	11,1	5,0
DRP05T1900060._					DRP05Q5858060._				
DRP05T2000060._	M 6	10	11,1	5,0	DRP06R3815080._				
DRP05T2300060._					DRP06Q3232080._	M 8	13	14,4	6,5
DRP05T3800060._					DRP06Q5858080._				
DRP06T2000080._					DRP08R3815100._				
DRP06T2300080._	M 8	13	14,4	6,5	DRP08Q3232100._	M 10	17	19,0	8,0
DRP06T3800080._					DRP08Q5858100._				
DRP08T2300100._	M 10	17	19,0	8,0					
DRP08T3800100._									

Le dimensioni sono indicative, non vincolanti, espresse in mm – Dimensions are indicative and not binding, expressed in mm

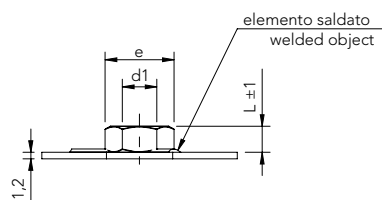

DRP 04 Q3232 050. 12

STEP 1 **STEP 2** **STEP 3** **STEP 4** **STEP 5**

Esempio di designazione: Dado filettato con piastrina passante quadrata, Q3232 filettatura M5, altezza 4 mm, in acciaio zincato
Example of code designation: Threaded nut with Q3232 square through-hole plate, M5 thread, 4mm height, zinc-plated steel

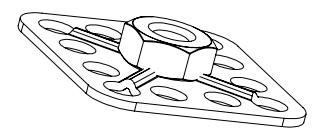

DRP04Q3232050.12

NOTA BENE: per conoscere le disponibilità e la fattibilità dei prodotti, contattare l'ufficio tecnico/commerciale Specialinsert® oppure consultare le schede tecniche scaricabili dal nostro sito www.specialinsert.it
NOTA BENE: for more information regarding product availability and feasibility, please contact the Specialinsert® tech/sales office or refer to the technical sheets downloadable at www.specialinsert.it

STEP 1 **CR** SERIE/SERIES

Chiodo con piastrina
Nail with plate

STEP 2 Lunghezze chiodo (L) 50 - 60 - 70 - 80 - 90 - 100
Nail lenght (L)

STEP 3 Tipo piastrina
Plate type



STEP 4 Diametro chiodo 3 mm
Nail diameter

STEP 5 Materiale Acciaio Inox 316 .51 316 Stainless Steel .51
Material

CODICE CODE	Lunghezza chiodo L±1mm Nail lenght L±1mm						CODICE CODE	Lunghezza chiodo L±1mm Nail lenght L±1mm					
	50	60	70	80	90	100		50	60	70	80	90	100
CR_T1900030.51							CR_Q1515030.51						
CR_T2000030.51							CR_Q3232030.51						
CR_T2300030.51							CR_R3815030.51						
CR_T3800030.51							CR_Q5858030.51						

Le dimensioni sono indicative, non vincolanti, espresse in mm – Dimensions are indicative and not binding, expressed in mm

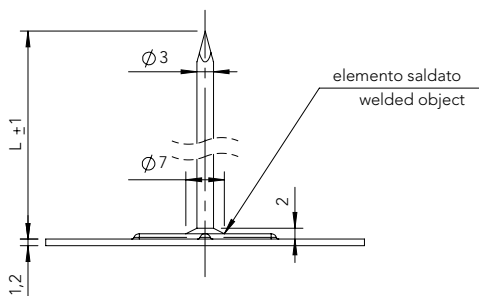

CR 70 Q5858 030. 51

STEP 1 **STEP 2** **STEP 3** **STEP 4** **STEP 5**

Esempio di designazione: Chiodo con piastrina
quadra Q5858, lunghezza 70 mm,
in acciaio inox 316
Example of code designation: Nail with Q5858
square plate, 70mm lenght, 316 stainless steel

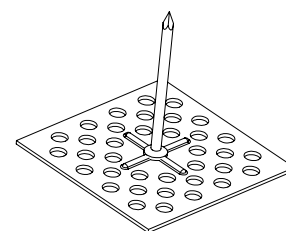

CR70Q5858030.51

NOTA BENE: per conoscere le disponibilità e la fattibilità dei prodotti, contattare l'ufficio tecnico/commerciale Specialinsert® oppure consultare le schede tecniche scaricabili dal nostro sito www.specialinsert.it
NOTA BENE: for more information regarding product availability and feasibility, please contact the Specialinsert® tech/sales office or refer to the technical sheets downloadable at www.specialinsert.it

PFR08 SERIE/SERIES

Piastrina passafascetta
Cable tie mount plate

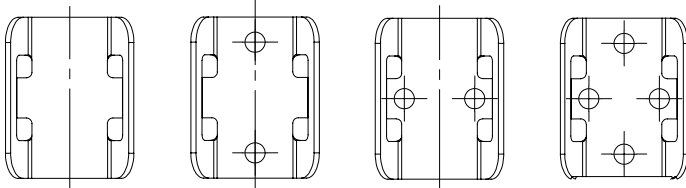

PFR08R3221000.51

PFR08R3221001.51

PFR08R3221002.51

PFR08R3221003.51

Materiale
Material

Acciaio Inox 316
316 Stainless Steel

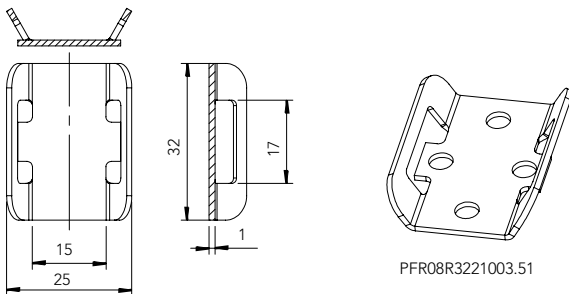

PFR08R3221003.51

Le dimensioni sono indicative, non vincolanti, espresse in mm – Dimensions are indicative and not binding, expressed in mm

PFR10 SERIE/SERIES

Piastrina passafascetta
Cable tie saddle plate

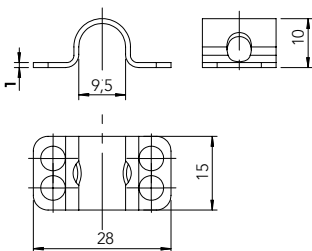

PFR10R2815001.51

Materiale
Material

Acciaio Inox 316
316 Stainless Steel

Le dimensioni sono indicative, non vincolanti, espresse in mm – Dimensions are indicative and not binding, expressed in mm

STEP 1 PRY SERIE/SERIES

Perno filettato con piastrina con piedini
Threaded stud with plate and round spacers



STEP 2 Lunghezza perno (L) Stud length (L)
10* - 12 - 16 - 20 - 25 - 30 - 40
* Non disponibile nella versione inox 316
* 316 Stainless Steel not available

Per lunghezza perno oltre 40 mm consultare la scheda PRSY (lunghezza min. a catalogo 45 mm)
For stud length over 40mm, see PRSY technical sheet (catalogue products min. length 45mm)

STEP 3 Tipo piastrina
Plate type



Y2000=Ø20

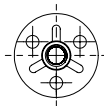

Y2300=Ø23

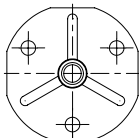

Y3800=Ø38

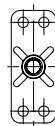

Y3815=38x15

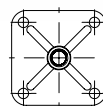

Y3232=32x32

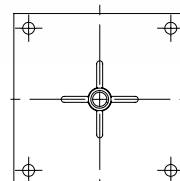

Y5858=58x58

STEP 4 Filetto (M)
Thread (M)

M4 - M5 - M6 - M8
Tolleranza 6g / Tolerance 6g
Per filetto M10 consultare la scheda PRSY
For M10 thread, see PRSY technical sheet

STEP 5 Materiale
Material

Acciaio Zincato .12 Zinc Plated Steel .12
Acciaio Inox 316 Elettrolucidato .56 Electropolished 316 Stainless Steel .56

CODICE CODE	d1 Filetto Thread	d2 Acciaio .12 Steel .12	d2 Inox .56 Stainless Steel .56	CODICE CODE	d1 Filetto Thread	d2 Acciaio .12 Steel .12	d2 Inox .56 Stainless Steel .56
PR_Y2000040._				PR_Y3815040._			
PR_Y2300040._	M 4	5,5	8,5	PR_Y3232040._	M 4	5,5	8,5
PR_Y3800040._				PR_Y5858040._			
PR_Y2000050._				PR_Y3815050._			
PR_Y2300050._	M 5	6,5	9,8	PR_Y3232050._	M 5	6,5	9,8
PR_Y3800050._				PR_Y5858050._			
PR_Y2000060._				PR_Y3815060._			
PR_Y2300060._	M 6	7,5	9,8	PR_Y3232060._	M 6	7,5	9,8
PR_Y3800060._				PR_Y5858060._			
PR_Y2000080._				PR_Y3815080._			
PR_Y2300080._	M 8	10,0	11,5	PR_Y3232080._	M 8	10,0	11,5
PR_Y3800080._				PR_Y5858080._			

Le dimensioni sono indicative, non vincolanti, espresse in mm - Dimensions are indicative and not binding, expressed in mm

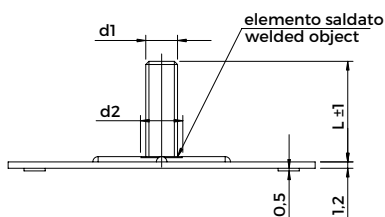

PR 20 Y3815 060. 12

STEP 1 **STEP 2** **STEP 3** **STEP 4** **STEP 5**

Esempio di designazione: Perno filettato con piastrina rettangolare Y3815, filettatura M6, lunghezza 20 mm, in acciaio zincato

Example of code designation: Threaded stud with Y3815 rectangular plate, M6 thread, 20mm length, zinc-plated steel

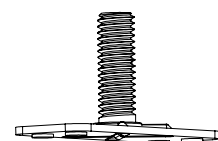

PR20Y3815060.12

NOTA BENE: per conoscere le disponibilità e la fattibilità dei prodotti, contattare l'ufficio tecnico/commerciale Specialinsert® oppure consultare le schede tecniche scaricabili dal nostro sito www.specialinsert.it
NOTA BENE: for more information regarding product availability and feasibility, please contact the Specialinsert® tech/sales office or refer to the technical sheets downloadable at www.specialinsert.it

STEP 1 PRSY SERIE/SERIES

Perno filettato con testa svasata con piastrina con piedini
Threaded stud with countersunk head and plate with round spacers



STEP 2 Lunghezze perno (L) 45 - 50 - 60 - 70 - 80 - 90 - 100
Stud Length (L) Per lunghezze perno inferiori a 45 mm consultare la scheda PRY (esclusa filettatura M10)
For stud length under 45mm, see PRY technical sheet (not including M10 thread)

STEP 3 Tipo piastrina
Plate type

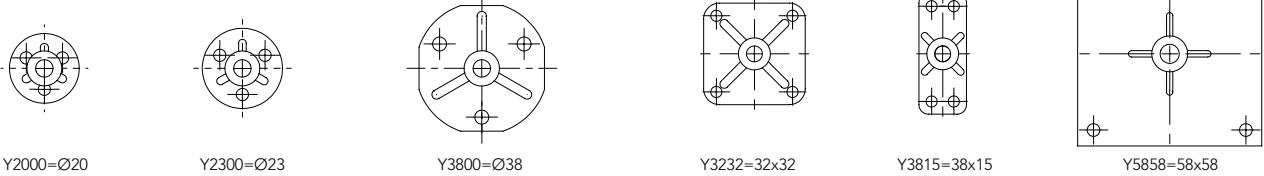

STEP 4 Filetto (M) M5 - M6 - M8 - M10
Thread (M) Tolleranza 6g / Tolerance 6g

STEP 5 Materiale Acciaio Zincato .12 Zinc Plated Steel .12
Material Acciaio Inox 316 Elettrolucidato .56 Electropolished 316 Stainless Steel .56

CODICE CODE	d1 Filetto Thread	d2 (max)	K +0,50 0	CODICE CODE	d1 Filetto Thread	d2 (max)	K +0,50 0
PRS_Y2000050._				PRS_Y3232050._			
PRS_Y2300050._	M 5	10	2,8	PRS_Y3815050._	M 5	10	2,8
PRS_Y3800050._				PRS_Y5858050._			
PRS_Y2000060._				PRS_Y3232060._			
PRS_Y2300060._	M 6	12	3,3	PRS_Y3815060._	M 6	12	3,3
PRS_Y3800060._				PRS_Y5858060._			
PRS_Y2000080._				PRS_Y3232080._			
PRS_Y2300080._	M 8	16	4,4	PRS_Y3815080._	M 8	16	4,4
PRS_Y3800080._				PRS_Y5858100._	M 10	20	5,5
PRS_Y3800100._	M 10	20	5,5				

Le dimensioni sono indicative, non vincolanti, espresse in mm – Dimensions are indicative and not binding, expressed in mm

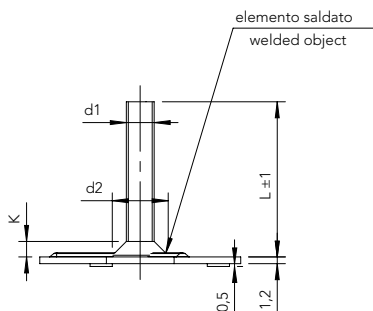

PRS 50 Y5858 050. 12

STEP 1 STEP 2 STEP 3 STEP 4 STEP 5

Esempio di designazione: Perno filettato con piastrina rettangolare Y3815, filettatura M5, lunghezza 50 mm, in acciaio zincato.
Example of code designation: Threaded stud with Y3815 rectangular plate, M5 thread, 50mm length, zinc-plated steel

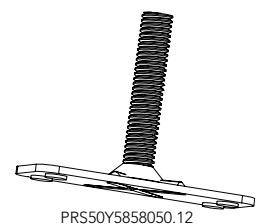

NOTA BENE: per conoscere le disponibilità e la fattibilità dei prodotti, contattare l'ufficio tecnico/commerciale Specialinsert® oppure consultare le schede tecniche scaricabili dal nostro sito www.specialinsert.it
NOTA BENE: for more information regarding product availability and feasibility, please contact the Specialinsert® tech/sales office or refer to the technical sheets downloadable at www.specialinsert.it

STEP 1 **BRCY** SERIE/SERIES

Boccola filettata con piastrina cieca con piedini
Threaded bush with blind plate and round spacers



STEP 2 Altezze boccola (L) 5 - 10 - 12 - 15 - 20 - 22 - 25
Bush height (L)

STEP 3 Tipo piastrina
Plate type

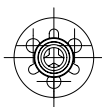

Y2000=ø20



Y2300=ø23

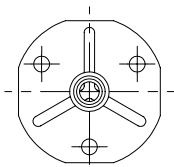

Y3800=ø38

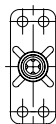

Y3815=38x15

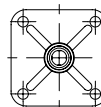

Y3232=32x32

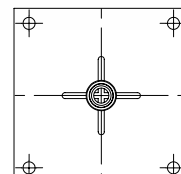

Y5858=58x58

STEP 4 Filetto (M) M4 - M5 - M6 - M8 - M10
Thread (M) Tolleranza 6H / Tolerance 6H

STEP 5 Materiale Acciaio Zincato .12 Zinc Plated Steel .12
Material Acciaio Inox 316 Elettrolucidato .56 Electropolished 316 Stainless Steel .56

CODICE CODE	d1 Filetto Thread	d2	d3	CODICE CODE	d1 Filetto Thread	d2	d3
BRC_Y2000040._				BRC_Y3815040._			
BRC_Y2300040._	M 4	12	8,3	BRC_Y3232040._	M 4	12	8,3
BRC_Y3800040._				BRC_Y5858040._			
BRC_Y2000050._				BRC_Y3815050._			
BRC_Y2300050._	M 5	13	9,6	BRC_Y3232050._	M 5	13	9,6
BRC_Y3800050._				BRC_Y5858050._			
BRC_Y2000060._				BRC_Y3815060._			
BRC_Y2300060._	M 6	13	9,6	BRC_Y3232060._	M 6	13	9,6
BRC_Y3800060._				BRC_Y5858060._			
BRC_Y2000080._				BRC_Y3815080._			
BRC_Y2300080._	M 8	15	11,0	BRC_Y3232080._	M 8	15	11,0
BRC_Y3800080._				BRC_Y5858080._			
BRC_Y2000100._				BRC_Y3815100._			
BRC_Y2300100._	M 10	16	12,6	BRC_Y3232100._	M 10	16	12,6
BRC_Y3800100._				BRC_Y5858100._			

N.B: L1= tratto utile filetto (max 3 volte ø) / NB L1= threaded length (max 3 times ø)

Le dimensioni sono indicative, non vincolanti, espresse in mm - Dimensions are indicative and not binding, expressed in mm

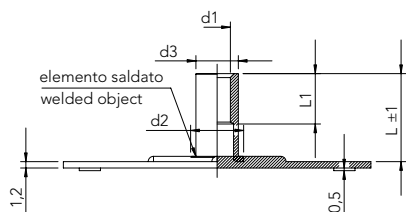

BRC 12 Y3815 050. 12

STEP 1 **STEP 2** **STEP 3** **STEP 4** **STEP 5**

Esempio di designazione: Boccola filettata con piastrina cieca rettangolare Y3815, filettatura M5, altezza 12 mm, in acciaio zincato
Example of code designation: Threaded bush with Y3815 rectangular blind plate, M5 thread, 12mm length, zinc-plated steel

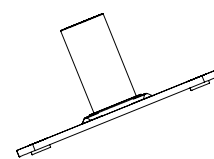

BRC12Y3815050.12

NOTA BENE: per conoscere le disponibilità e la fattibilità dei prodotti, contattare l'ufficio tecnico/commerciale Specialinsert® oppure consultare le schede tecniche scaricabili dal nostro sito www.specialinsert.it
NOTA BENE: for more information regarding product availability and feasibility, please contact the Specialinsert® tech/sales office or refer to the technical sheets downloadable at www.specialinsert.it

STEP 1 **BRPY** SERIE/SERIES

Boccola filettata con piastrina passante con piedini
Threaded bush with through-hole plate and round spacers



STEP 2 Altezze boccola (L) 5 - 10 - 12 - 15 - 20 - 22 - 25
Bush height (L)

STEP 3 Tipo piastrina
Plate type

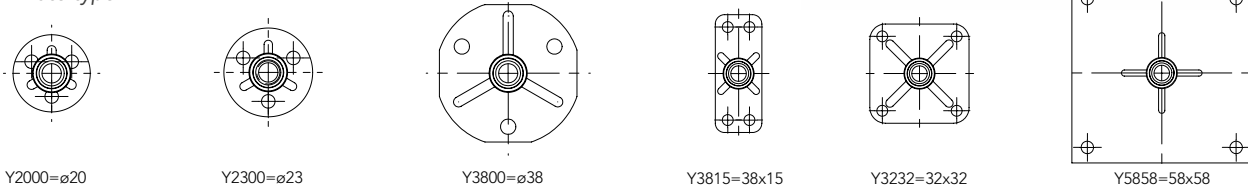

STEP 4 Filetto (M) M4 - M5 - M6 - M8 - M10
Thread (M) Tolleranza 6H / Tolerance 6H

STEP 5 Materiale Acciaio Zincato .12 Zinc Plated Steel .12
Material Acciaio Inox 316 Elettrolucidato .56 Electropolished 316 Stainless Steel .56

CODICE CODE	d1 Filetto Thread	d2	d3	CODICE CODE	d1 Filetto Thread	d2	d3
BRP_Y2000040._				BRP_Y3815040._			
BRP_Y2300040._	M 4	12	8,3	BRP_Y3232040._	M 4	12	8,3
BRP_Y3800040._				BRP_Y5858040._			
BRP_Y2000050._				BRP_Y3815050._			
BRP_Y2300050._	M 5	13	9,6	BRP_Y3232050._	M 5	13	9,6
BRP_Y3800050._				BRP_Y5858050._			
BRP_Y2000060._				BRP_Y3815060._			
BRP_Y2300060._	M 6	13	9,6	BRP_Y3232060._	M 6	13	9,6
BRP_Y3800060._				BRP_Y5858060._			
BRP_Y2300080._	M 8	15	11,0	BRP_Y3815080._			
BRP_Y3800080._				BRP_Y3232080._	M 8	15	11,0
BRP_Y3800100._	M 10	16	12,6	BRP_Y5858080._			
				BRP_Y3232100._	M 10	16	12,6
				BRP_Y5858100._			

N.B: L1= tratto utile filetto (max 3 volte ø) / NB L1= threaded length (max 3 times ø)

Le dimensioni sono indicative, non vincolanti, espresse in mm – Dimensions are indicative and not binding, expressed in mm

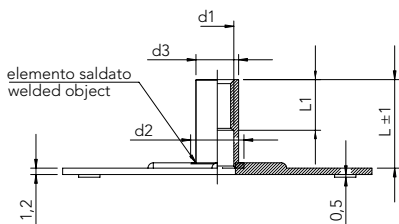

BRP 12 Y3815 050. 12

STEP 1 **STEP 2** **STEP 3** **STEP 4** **STEP 5**

Esempio di designazione: Boccola filettata con piastrina passante rettangolare Y3815, filettatura M5, altezza 12 mm, in acciaio zincato
Example of code designation: Threaded bush with Y3815 rectangular through-hole plate, M5 thread, 12mm length, zinc-plated steel

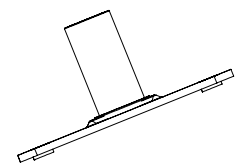

BRP12Y3815050.12

NOTA BENE: per conoscere le disponibilità e la fattibilità dei prodotti, contattare l'ufficio tecnico/commerciale Specialinsert® oppure consultare le schede tecniche scaricabili dal nostro sito www.specialinsert.it
NOTA BENE: for more information regarding product availability and feasibility, please contact the Specialinsert® tech/sales office or refer to the technical sheets downloadable at www.specialinsert.it

STEP 1 DFCY SERIE/SERIES

Dado flangiato con piastrina cieca con piedini
Flanged nut with blind plate and round spacers



STEP 2 Altezze dado (L) 4,3 - 4,8 - 5,4
Nut height (L)

STEP 3 Tipo piastrina
Plate type



Y2000=Ø20



Y2300=Ø23

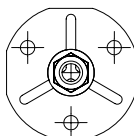

Y3800=Ø38

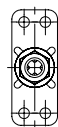

Y3815=38x15

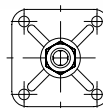

Y3232=32x32

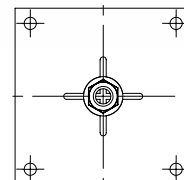

Y5858=58x58

STEP 4 Filetto (M) M4 - M5 - M6
Thread (M) Tolleranza 6H / Tolerance 6H

STEP 5 Materiale Acciaio Zincato .12 Zinc Plated Steel .12
Material Acciaio Inox 316 Elettrolucidato .56 Electropolished 316 Stainless Steel .56

CODICE CODE	d1 Filetto Thread	Chiave esagono Hex Key	e	d2	L	CODICE CODE	d1 Filetto Thread	Chiave esagono Hex Key	d2	L
DFC04Y2000040._						DFC04Y3815040._				
DFC04Y2300040._	M 4	7	7,8	9,10	4,3	DFC04Y3232040._	M 4	7	9,10	4,3
DFC04Y3800040._						DFC04Y5858040._				
DFC05Y2000050._						DFC05Y3815050._				
DFC05Y2300050._	M 5	8	8,9	10,50	4,8	DFC05Y3232050._	M 5	8	10,50	4,8
DFC05Y3800050._						DFC05Y5858050._				
DFC06Y2000060._						DFC06Y3815060._				
DFC06Y2300060._	M 6	10	11,1	12,95	5,4	DFC06Y3232060._	M 6	10	12,95	5,4
DFC06Y3800060._						DFC06Y5858060._				

Le dimensioni sono indicative, non vincolanti, espresse in mm - Dimensions are indicative and not binding, expressed in mm

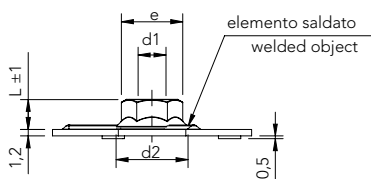

DFC 05 Y3815 050. 12

STEP 1 STEP 2 STEP 3 STEP 4 STEP 5

Esempio di designazione: Dado filettato flangiato con piastrina cieca rettangolare Y3815, filettatura M5, altezza 4,8 mm, in acciaio zincato
Example of code designation: Flanged threaded nut with Y3815 rectangular blind plate, M5 thread, 4,8mm height, zinc-plated steel



DFC05Y3815050.12

NOTA BENE: per conoscere le disponibilità e la fattibilità dei prodotti, contattare l'ufficio tecnico/commerciale Specialinsert® oppure consultare le schede tecniche scaricabili dal nostro sito www.specialinsert.it
NOTA BENE: for more information regarding product availability and feasibility, please contact the Specialinsert® tech/sales office or refer to the technical sheets downloadable at www.specialinsert.it

STEP 1 DFPY SERIE/SERIES

Dado flangiato con piastrina passante con piedini
Flanged nut with through-hole plate and round spacers

STEP 2 Altezze dado (L) 4,3 – 4,8 – 5,4
Nut height (L)

STEP 3 Tipo piastrina
Plate type



Y2000=ø20



Y2300=ø23

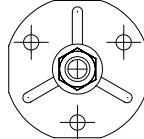

Y3800=ø38

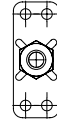

Y3815=38x15

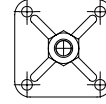

Y3232=32x32

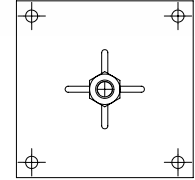

Y5858=58x58

STEP 4 Filetto (M) M4 - M5 - M6
Thread (M) Tolleranza 6H / Tolerance 6H

STEP 5 Materiale Acciaio Zincato .12 Zinc Plated Steel .12
Material Acciaio Inox 316 Elettrolucidato .56 Electropolished 316 Stainless Steel .56

CODICE CODE	d1 Filetto Thread	Chiave esagono Hex Key	e	d2	L	CODICE CODE	d1 Filetto Thread	Chiave esagono Hex Key	e	d2	L
DFP04Y2000040._						DFP04Y3815040._					
DFP04Y2300040._	M 4	7	7,8	9,10	4,3	DFP04Y3232040._	M 4	7	7,8	9,1	4,3
DFP04Y3800040._						DFP04Y5858040._					
DFP05Y2000050._						DFP05Y3815050._					
DFP05Y2300050._	M 5	8	8,9	10,50	4,8	DFP05Y3232050._	M 5	8	8,9	10,5	4,8
DFP05Y3800050._						DFP05Y5858050._					
DFP06Y2300060._	M 6	10	11,1	12,95	5,4	DFP06Y3815060._					
DFP06Y3800060._						DFP06Y3232060._	M 6	10	11,1	12,95	5,4
						DFP06Y5858060._					

Le dimensioni sono indicative, non vincolanti, espresse in mm – Dimensions are indicative and not binding, expressed in mm

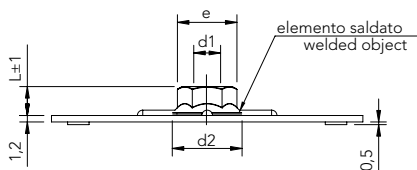
**DFP 05 Y3815 050. 12**

STEP 1 **STEP 2** **STEP 3** **STEP 4** **STEP 5**

Esempio di designazione: Dado filettato flangiato con piastrina passante rettangolare Y3815, filettatura M5, altezza 4,8 mm, in acciaio zincato
Example of code designation: Flanged threaded nut with Y3815 rectangular through-hole plate, M5 thread, 4,8mm height, zinc-plated steel

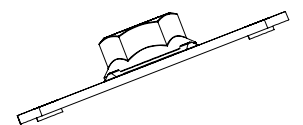

DFP05Y3815050.12

NOTA BENE: per conoscere le disponibilità e la fattibilità dei prodotti, contattare l'ufficio tecnico/commerciale Specialinsert® oppure consultare le schede tecniche scaricabili dal nostro sito www.specialinsert.it
NOTA BENE: for more information regarding product availability and feasibility, please contact the Specialinsert® tech/sales office or refer to the technical sheets downloadable at www.specialinsert.it

STEP 1 **DRCY** SERIE/SERIES

Dado con piastrina cieca con piedini
Nut with blind plate and round spacers



STEP 2 Altezza dado (L) 6,5 – 8,0
Nut height (L)

STEP 3 Tipo piastrina
Plate type



Y2000=ø20



Y2300=ø23

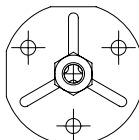

Y3800=ø38

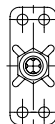

Y3815=38x15

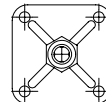

Y3232=32x32

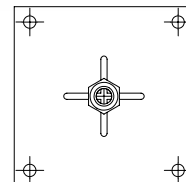

Y5858=58x58

STEP 4 Filetto (M) M8 - M10
Thread (M) Tolleranza 6H / Tolerance 6H

STEP 5 Materiale Acciaio Zincato .12 Zinc Plated Steel .12
Material Acciaio Inox 316 Elettrolucidato .56 Electropolished 316 Stainless Steel .56

CODICE CODE	d1 Filetto Thread	Chiave esagono Hex Key	e	L	CODICE CODE	d1 Filetto Thread	Chiave esagono Hex Key	e	L
DRC06Y2300080._	M 8	13	14,4	6,5	DRC06Y3815080._	M 8	13	13	6,5
DRC06Y3800080._	M 8	13	14,4	6,5	DRC06Y5858080._	M 8	13	13	6,5
DRC08Y2300100._	M 10	17	19,0	8,0	DRC08Y3815100._	M 10	17	17	8,0
DRC08Y3800100._	M 10	17	19,0	8,0	DRC08Y3232100._	M 10	17	17	8,0
					DRC08Y5858100._	M 10	17	17	8,0

Le dimensioni sono indicative, non vincolanti, espresse in mm – Dimensions are indicative and not binding, expressed in mm

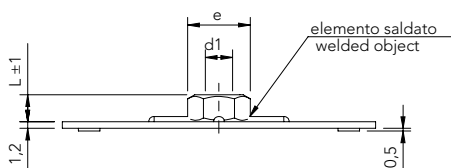

DRC 06 Y3815 080. 12

STEP 1 STEP 2 STEP 3 STEP 4 STEP 5

Esempio di designazione: Dado filettato con piastrina cieca rettangolare Y3815, filettatura M8, altezza 6,5 mm, in acciaio zincato
Example of code designation: Threaded nut with Y3815 rectangular blind plate, M8 thread, 6,5mm height, zinc-plated steel

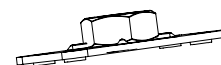

DRC06 Y3815 080.12

NOTA BENE: per conoscere le disponibilità e la fattibilità dei prodotti, contattare l'ufficio tecnico/commerciale Specialinsert® oppure consultare le schede tecniche scaricabili dal nostro sito www.specialinsert.it
NOTA BENE: for more information regarding product availability and feasibility, please contact the Specialinsert® tech/sales office or refer to the technical sheets downloadable at www.specialinsert.it

STEP 1 **DRPY** SERIE/SERIES

Dado con piastrina passante con piedini
Nut with through-hole plate and round spacers



STEP 2 Altezza dado (L) 6,5 – 8,0
Nut height (L)

STEP 3 Tipo piastrina
Plate type



Y2000=ø20



Y2300=ø23

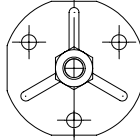

Y3800=ø38

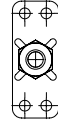

Y3815=38x15

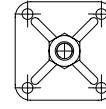

Y3232=32x32

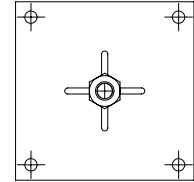

Y5858=58x58

STEP 4 Filetto (M) M8 - M10
Thread (M) Tolleranza 6H / Tolerance 6H

STEP 5 Materiale Acciaio Zincato .12 Zinc Plated Steel .12
Material Acciaio Inox 316 Elettrolucidato .56 Electropolished 316 Stainless Steel .56

CODICE CODE	d1 Filetto Thread	Chiave esagono Hex Key	e	L	CODICE CODE	d1 Filetto Thread	Chiave esagono Hex Key	e	L
DRP06Y2300080._	M 8	13	14,4	6,5	DRP06Y3815080._	M 8	13	14,4	6,5
DRP06Y3800080._	M 8	13	14,4	6,5	DRP06Y5858080._	M 8	13	14,4	6,5
DRP08Y3800100._	M 10	17	19,0	8,0	DRP08Y3815100._	M 10	17	19,0	8,0
					DRP08Y3232100._	M 10	17	19,0	8,0
					DRP08Y5858100._	M 10	17	19,0	8,0

Le dimensioni sono indicative, non vincolanti, espresse in mm – Dimensions are indicative and not binding, expressed in mm

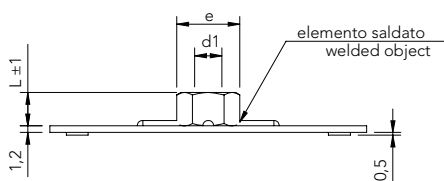
DRP 06 Y3815 080. 12

STEP 1 **STEP 2** **STEP 3** **STEP 4** **STEP 5**

Esempio di designazione: Dado filettato con piastrina passante rettangolare Y3815, filettatura M8, altezza 6,5 mm, in acciaio zincato
Example of code designation: Threaded nut with Y3815 rectangular through-hole plate, M8 thread, 6,5 mm height, zinc-plated steel

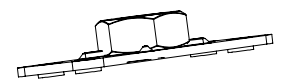

DRP06Y3815080.12

NOTA BENE: per conoscere le disponibilità e la fattibilità dei prodotti, contattare l'ufficio tecnico/commerciale Specialinsert® oppure consultare le schede tecniche scaricabili dal nostro sito www.specialinsert.it
NOTA BENE: for more information regarding product availability and feasibility, please contact the Specialinsert® tech/sales office or refer to the technical sheets downloadable at www.specialinsert.it

STEP 1 **CRY** SERIE/SERIES

Chiodo con piastrina con piedini
Nail with plate and round spacers

STEP 2 Lunghezze chiodo (L) 50 - 60 - 70 - 80 - 90 - 100
Nail lenght (L)

STEP 3 Tipo piastrina
Plate type



Y2000=ø20



Y2300=ø23

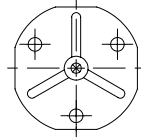

Y3800=ø38

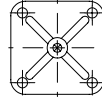

Y3232=32x32

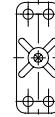

Y3815=38x15

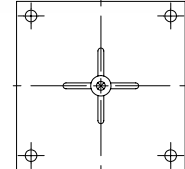

Y5858=58x58

STEP 4 Diametro chiodo 3 mm
Nail diameter

STEP 5 Materiale Acciaio Inox 316 Elettrolucidato .56 Electropolished 316 Stainless Steel .56
Material

CODICE CODE	Lunghezza chiodo L±1mm Nail lenght L±1mm						CODICE CODE	Lunghezza chiodo L±1mm Nail lenght L±1mm					
CRY_Y2000030.56							CRY_Y3232030.56						
CRY_Y2300030.56	50	60	70	80	90	100	CRY_Y3815030.56	50	60	70	80	90	100
CRY_Y3800030.56							CRY_Y5858030.56						

Le dimensioni sono indicative, non vincolanti, espresse in mm – Dimensions are indicative and not binding, expressed in mm

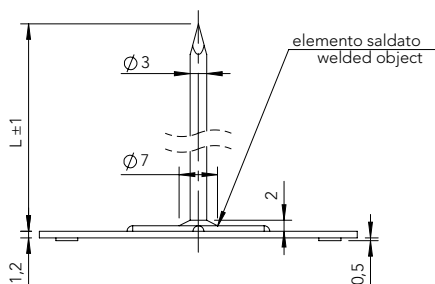

CRY 70 Y5858 030. 56

STEP 1 **STEP 2** **STEP 3** **STEP 4** **STEP 5**

Esempio di designazione: Chiodo con piastrina quadra Y5858, lunghezza 70 mm, in acciaio inox 316 elettrolucidato
Example of code designation: Nail with Y5858 square plate, lenght 70mm, electropolished 316 stainless steel

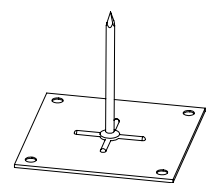

CRY70Y5858030.56

NOTA BENE: per conoscere le disponibilità e la fattibilità dei prodotti, contattare l'ufficio tecnico/commerciale Specialinsert® oppure consultare le schede tecniche scaricabili dal nostro sito www.specialinsert.it
NOTA BENE: for more information regarding product availability and feasibility, please contact the Specialinsert® tech/sales office or refer to the technical sheets downloadable at www.specialinsert.it

PFRY08 SERIE/SERIES

Piastrina passafascetta con piedini
 Cable tie mount plate with round spacers

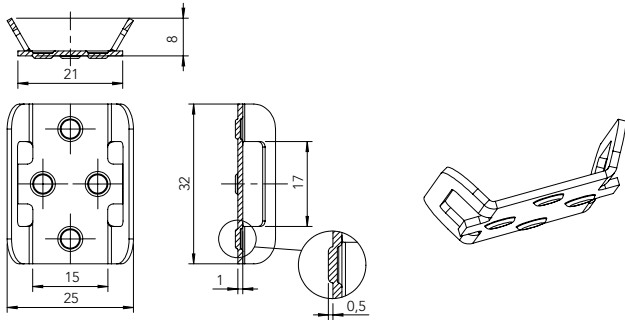

PFRY08R3221004.51

Materiale
 Material

Acciaio Inox 316
 Stainless Steel 316

Le dimensioni sono indicative, non vincolanti, espresse in mm – Dimensions are indicative and not binding, expressed in mm

FAD03T38.51

Fermagli per pannelli
Spring clips

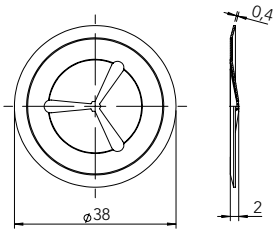

Materiale
Material

Acciaio Inox AISI 316
AISI 316 Stainless Steel

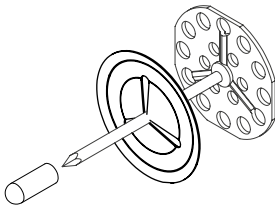

Le dimensioni sono indicative, non vincolanti, espresse in mm – Dimensions are indicative and not binding, expressed in mm

EE109-500

Cappucci per chiodi
Caps for nails

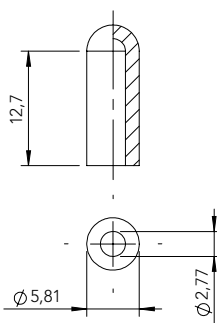

Materiale
Material

EPDM resistente fino a 177°C
EPDM resistant up to 177°C

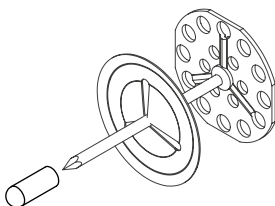

Le dimensioni sono indicative, non vincolanti, espresse in mm – Dimensions are indicative and not binding, expressed in mm

NOTA BENE: per conoscere le disponibilità e la fattibilità dei prodotti, contattare l'ufficio tecnico/commerciale Specialinsert® oppure consultare le schede tecniche scaricabili dal nostro sito www.specialinsert.it
NOTA BENE: for more information regarding product availability and feasibility, please contact the Specialinsert® tech/sales office or refer to the technical sheets downloadable at www.specialinsert.it

MP/CPP

Tappi per protezione fori con maniglia di estrazione
 Plugs with handle for holes protection

Prodotto solo su richiesta – On demand only

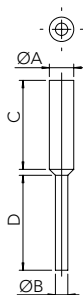

Materiale
 Material

Silicone resistente fino a 315°C
 Silicone resistant up to 315°C

CODICE CODE	Per filetto For thread	A	B	C	D
MP/CPP20	M 4	3,96	1,57	15,88	19,05
MP/CPP23	M 5	4,80	3,10	32,10	30,25
MP/CPP37	M 6	5,40	3,00	31,25	29,70
MP/CPP42	M 8	7,20	3,50	25,15	25,60
MP/CPP50	M 10	8,80	4,75	31,19	28,75

Le dimensioni sono indicative, non vincolanti, espresse in mm – Dimensions are indicative and not binding, expressed in mm

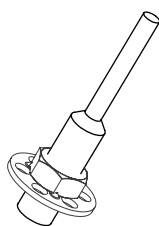

NOTA BENE: per conoscere le disponibilità e la fattibilità dei prodotti, contattare l'ufficio tecnico/commerciale Specialinsert® oppure consultare le schede tecniche scaricabili dal nostro sito www.specialinsert.it
 NOTA BENE: for more information regarding product availability and feasibility, please contact the Specialinsert® tech/sales office or refer to the technical sheets downloadable at www.specialinsert.it

SPECIALI - SPECIALS

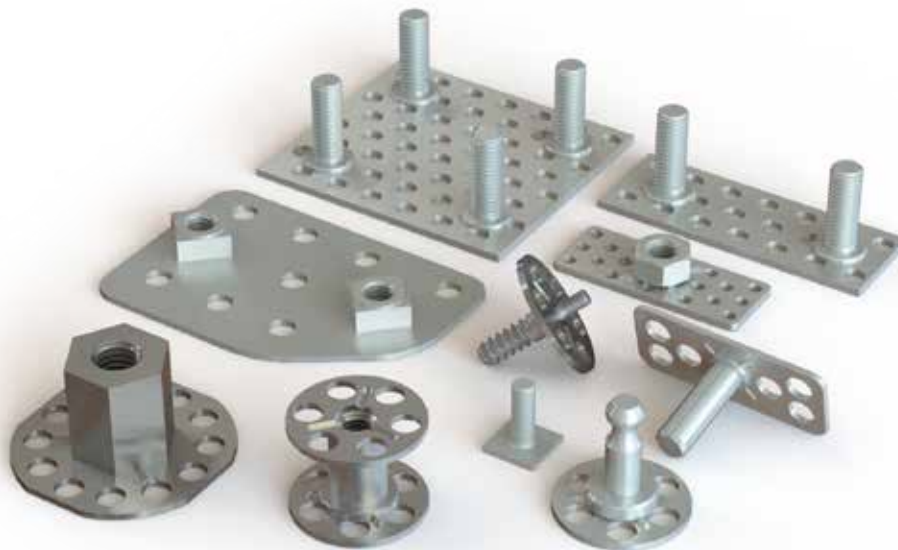

Specialinsert® inoltre è in grado di fornire prodotti speciali su richiesta del cliente. Per ulteriori informazioni contattare il servizio tecnico **Specialinsert®**.

*Specialinsert® is also able to supply special custom products on demand. For further information please contact **Specialinsert®** technical department.*

Alcuni Master-Plate® speciali realizzati:
Examples of custom-made Master-Plate® products made:



Perno Speciale con elemento di centraggio sotto piastrina, per garantire il corretto posizionamento su telaio automotive.
Custom stud with a centering element under the plate, to ensure correct positioning on the automotive chassis.

Piastrina a disegno con doppio dado orientato. Applicazione speciale per cofano motore.
Customer drawing plate with double oriented nut. Special application for engine hood.

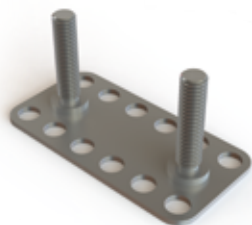

Piastrina a disegno con doppio perno. Applicazione: settore ferroviario.
Customer drawing plate with double stud. Application: railway sector.

Perno in alluminio con filettatura speciale, saldato su piastrina in alluminio. Applicazione: cablaggi automotive.
Aluminium stud with special thread, welded on aluminium plate. Application: automotive wiring.

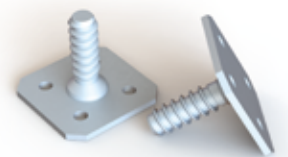

NOTA BENE: per conoscere le disponibilità e la fattibilità dei prodotti, contattare l'ufficio tecnico/commerciale **Specialinsert®** oppure consultare le schede tecniche scaricabili dal nostro sito www.specialinsert.it
NOTA BENE: for more information regarding product availability and feasibility, please contact the **Specialinsert®** tech/sales office or refer to the technical sheets downloadable at www.specialinsert.it

SPECIALI - SPECIALS

Serie DS (Dimple Spacers)

Sistema composto da una BASE FORATA con la presenza di GRIFFE (DIMPLE SPACERS) e da un elemento di fissaggio. Le griffe agli angoli della piastrina fungono da punto d'arresto in fase di installazione garantendo uno spessore di collante minimo di 0,5 mm.

System composed of a PERFORATED BASE with DIMPLE SPACERS and a fastener. The Dimple Spacers at the corner of the plate act as a stopping point during installation, guaranteeing a minimum adhesive thickness of 0,5mm.

Specialinsert® è in grado di replicare l'intera gamma Master-Plate® con la serie DS.

Specialinsert® can provide the full Master-Plate® range as DS series.

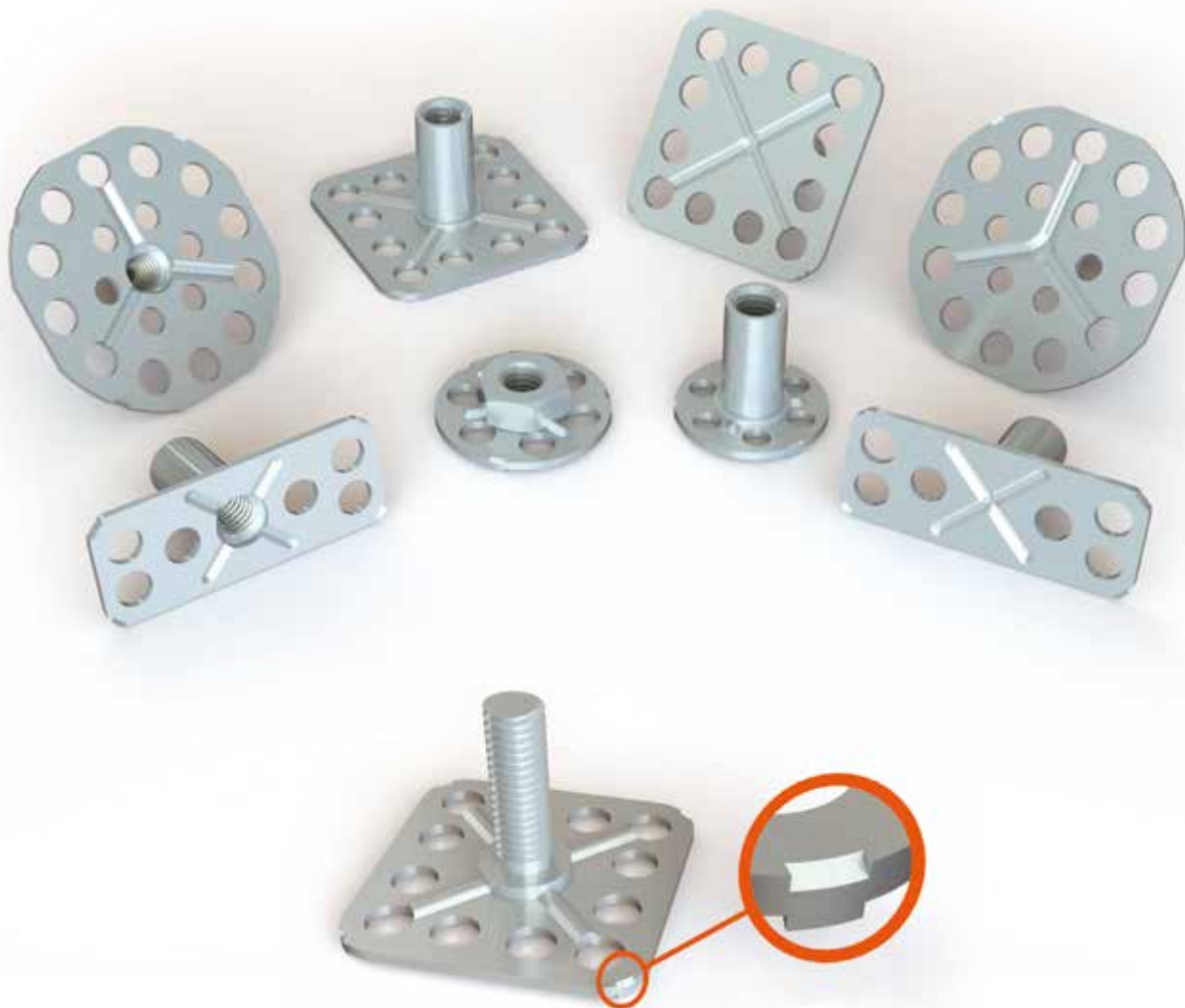

NOTA BENE: per conoscere le disponibilità e la fattibilità dei prodotti, contattare l'ufficio tecnico/commerciale Specialinsert® oppure consultare le schede tecniche scaricabili dal nostro sito www.specialinsert.it
 NOTA BENE: for more information regarding product availability and feasibility, please contact the Specialinsert® tech/sales office or refer to the technical sheets downloadable at www.specialinsert.it

SERVIZI E PROCESSI

Assistenza tecnica dei nostri commerciali prima, durante e post consegna dei prodotti, con consigli mirati per l'acquisto del sistema di fissaggio più adatto per lo scopo. Grazie a questo nostro servizio i clienti avranno sempre un punto fermo a cui rivolgersi in caso di problematiche: il tecnico **Specialinsert®**.

Nei nostri laboratori si eseguono controlli della produzione e prove a supporto delle specifiche applicazioni cliente, tra cui:

- **Trazione**
- **Torsione**
- **Durezza**
- **Compressione**
- **Controllo apparecchiature**
- **Controllo statistico di processo**

ASSISTENZA VENDITE

I funzionari tecnico-commerciali, alle dirette dipendenze della **Specialinsert®**, sono in grado di valutare le vostre esigenze e dotati di tutto ciò che serve per effettuare dimostrazioni pratiche presso i vostri stabilimenti.

QUALITÀ

La Direzione **Specialinsert®** ha implementato un Sistema integrato di Gestione per la Qualità e per la Sicurezza e Salute sul lavoro definendo la Politica aziendale e le procedure di sistema documentate.

La Politica per la Qualità e Sicurezza rappresenta interamente gli intendimenti della Direzione ed è considerata parte integrante e prioritaria per l'intera gestione aziendale. Essa viene definita e approvata periodicamente. La presenza all'interno dell'azienda dei laboratori tecnologici e dell'ufficio studi permette a **Specialinsert®** di trovare sempre nuove soluzioni di fissaggio sia su specifiche problematiche dei clienti, che da proprie ricerche. Grazie alle unità sopra descritte sono stati depositati diversi marchi e vari brevetti.

RICERCA E SVILUPPO

La presenza all'interno dell'azienda dei laboratori tecnologici e dell'ufficio studi permette a **Specialinsert®** di trovare sempre nuove soluzioni di fissaggio sia su specifiche problematiche dei clienti, che da proprie ricerche. Grazie alle unità sopra descritte sono stati depositati diversi marchi e vari brevetti.

PERCHÉ SCEGLIERE SPECIALINSERT®?

- **Ricerca e Sviluppo.**
- **Assistenza costante.**
- **Continua innovazione tecnologica.**
- **Rete di vendita tecnicamente qualificata alle dirette dipendenze.**
- **Soluzioni a 360° per ogni settore, versatilità, flessibilità, dinamismo.**
- **Alta specializzazione.**





SERVICES AND PROCESSES

Technical assistance is supplied by our sales team before, during and after product delivery by providing targeted advice to buy the most suitable fasteners for all purposes. Our customers know they have someone they can rely on to solve problems: their **Specialinsert®** technician.

In our technical labs, production checks and tests are carried out in support of specific customer applications, including:

- **Pull-out tests**
- **Torque tests**
- **Compression tests**
- **Hardness tests**
- **Equipment inspection**
- **Statistic process monitoring**

SALES ASSISTANCE

Our technical sales staff, directly employed by **Specialinsert®**, is able to assess your needs and is fully equipped to set up practical demonstrations at your plant.

QUALITY

Specialinsert® has an integrated Global Safety & Quality System. Policies of both systems are seen as an integral, priority part of company management as a whole. The company's managers periodically update and approve the Quality Assurance & Safety Policy. **Specialinsert®** is IATF certified, the international quality standard for the automotive sector. A recognition that guarantees efficiency and effectiveness throughout the production process, customer satisfaction and continuous improvement.

R&D

Our testing labs and R&D office are constantly seeking new fastening solutions, providing answers to our customers' request and developing their own lines of research. As a result, **Specialinsert®** has filed many patents and various trademarks

WHY CHOOSE SPECIALINSERT®?

- **R&D**
- **Continuous assistance**
- **Continuous technological innovation**
- **Technically qualified sales staff directly employed by the company**
- **360° solutions for all fields, versatility, flexibility and dynamism**
- **High specialization**



SEDE TORINO | HEADQUARTER AND EXPORT DEPARTMENT
Via Monfalcone, 144 - 10136 - Torino (Italy) - Tel. +39 011.700.301 R.A. - Fax +39 011.702.947

FILIALI E STABILIMENTO | PRODUCTION DEPARTMENT AND BRANCH
Via E. Cialdini 37 - 20161 - Milano (Italy) - Tel. +39 02.646.84.76 R.A. - Fax +39 02.662.002.75
Via E. Pavanello 1 - 30030 - Maerne di Martellago (VE - Italy) - Tel. +39 041.503.01.00 R.A. - Fax +39 041.503.01.10

WWW.SPECIALINSERT.IT
INFO@SPECIALINSERT.IT - EXPORT@SPECIALINSERT.IT