

Application: fiberglass, composite materials and others.  
 Assembly: bonding, rolling, moulding.



chemical-concepts.com

**800.220.1966**

410 Pike Road • Huntingdon Valley, PA 19006

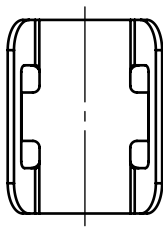

PFR08R3221000.51

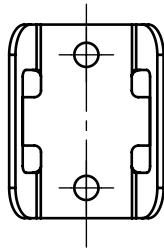

PFR08R3221001.51

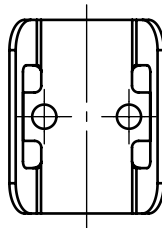

PFR08R3221002.51

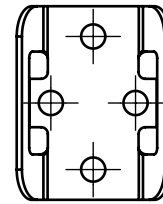

PFR08R3221003.51

Dimensions are indicative and not binding, expressed in mm.

Other details and materials on request.

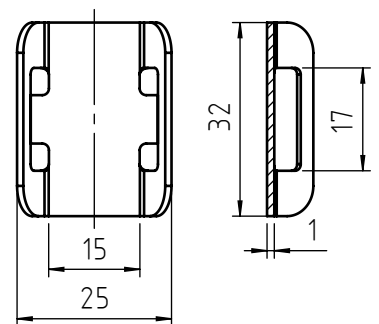
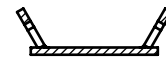

■ Standard      □ On demand

Material: stainless steel AISI 316  
 Finishing: natural state

Tolerance: where not specified, coarse degree of accuracy,  
 according to ISO 2768-m

Example of designation: stainless steel cable tie plate AISI 316  
 two holes on the short side:

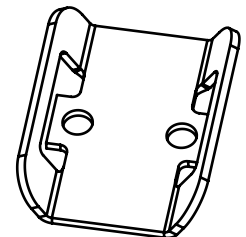

PFR08R3221001.51

Headquarter and Export department:  
 Via Monfalcone 144 - 10136 - Turin - IT - Tel. +39.011.700301 - Fax +39.011.702947  
 Milan branch:  
 Via E. Cialdini 37 - 20161 - Milan - IT - Tel. +39.02.646.8476 - Fax +39.02.662.00275  
 Production and purchase departments:  
 Via E. Pavanello 1 - 30030 - Maerne di Martellago (Venice) - IT - Tel. +39.041.503.0100  
 Fax +39.041.503.0110

SPECIALINSERT® COMMITS ITSELF TO CONTINUOUSLY IMPROVE ITS PRODUCTS. IT RESERVES THE RIGHT TO CHANGE THEIR TECHNICAL AND STRUCTURAL CHARACTERISTICS WITHOUT PRIOR NOTICE. ALL RIGHTS ARE RESERVED AND THE DUPLICATION, EVEN PARTIAL OF THESE DOCUMENTS, AS WELL AS ITS DISTRIBUTION TO THIRD PARTIES ARE FORBIDDEN, UNLESS OTHERWISE AND EXPRESSLY AUTHORIZED BY SPECIALINSERT.