

Anchoring



KEEP-NUT™ Press-in Self-anchoring Insert

KEEP-NUT™ Press-in self-anchoring sink fasteners are the strongest and most efficient mounting system for 12mm porcelain, and other hard surfaces. Originally designed to support building **facades**, **vertical wall panels and furniture**, the KEEP-NUT™ also offers exceptional performance for **sink mounting**.

- Quick Assembly by Pressure
- No Need for Resins or Adhesives
- High Strength, even in thin materials
- Save Time & Money

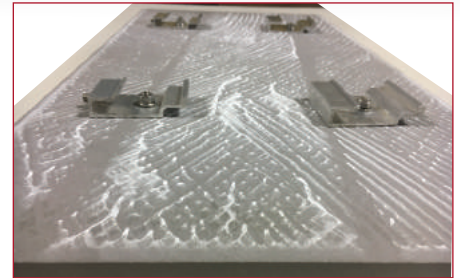

Drilling Methods:

CNC Router



KDM110

KEEP-NUT™ Drilling Machine



- Can be drilled with standard tools (CNC or Drilling Machine)
- Average Strength of 562 lbs per Insert
- Crowns (or Teeth) Provide Axial Strength and Flex, Providing Higher Strength
- Simple Drilling

CCH-KN-KDM110
(Vacuum Drilling Machine w/Polisher)

Which Bit is Right for Me?

Type of Bit	Drilling Method
11.8 mm 5/8-11 Porcelain Bit	KEEP-NUT™ Drilling Machine
11.8 mm 1/2 Gas CNC Porcelain Bit	CNC Router

KEEP-NUT™ Insert & Pull-Out Strength

Part	Minimum Surface Thickness	Thread (d1)*	Hole Depth (L2)	Hole Diameter (d2)	Threaded Post Depth (h1)	Number of Crowns	Average Pull-Out Strength
IM1S/P1.4-.20/H5	0.31" 8.0 mm	1/4-20	0.22" 5.5 mm	12 mm	0.18" 4.5 mm	1	202 lbf 0.9kN
IM2S/P1.4-.20/H6	0.34" 8.5 mm	1/4-20	0.26" 6.5 mm	12 mm	0.22" 5.5 mm	2	562 lbf 2.5 kN

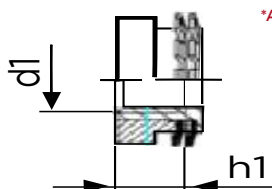

*Additional Thread Sizes Available

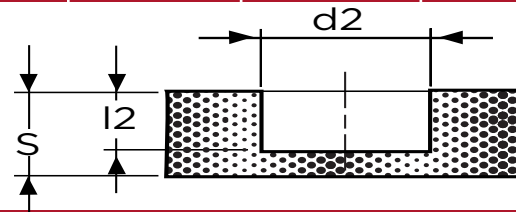

KEEP-NUT[™] Parts and Kits



Individual Items: As a fabricator you may want to purchase all items from us or just the **KEEP-NUT[™]** Inserts by themselves, see part numbers and kits below:

KEEP-NUT[™] SKU: SPE-IM1S/P1.4-20/H5		1 Crown KEEP-NUT[™] Insert Average Strength of 202 lbs per Insert
KEEP-NUT[™] SKU: SPE-IM2S/P1.4-20/H6		2 Crown KEEP-NUT[™] Insert Average Strength of 562 lbs per Insert
Z-Shaped Sink Clips SKU: CCH732G		Z-Shaped Sink Clip used to support the undermount Sink
Allen Posts SKU: CCH-KNPOST		1/4-20 Thread x 1-1/4" Length Male Posts <i>Additional 1-1/2"L Post, 1/4-20 Thread sizes available 1-3/4"L Post, 1/4-20 Thread</i>
Wingnuts SKU: CCH730S		1/4-20 Thread Wingnut
Star Washers SKU: CCH731		1/4-20 Thread Flat Star Washer
Lock-Nuts SKU: CCH734K		1/4-20 Thread Lock Nut (Optional, replaces Wingnut & Star Washer)

Drill Bits & Installation Accessories:

11.8 mm CNC Porcelain Bit SKU: CCH-KNBITCNC-11.8-D		11.8 mm 1/2 GAS CNC Bit for Porcelain
11.8 mm Manual Porcelain Bit SKU: CCH-KNBITGRI-11.8-D		11.8 mm Diameter, 5/8-11 Thread Porcelain Bit for Manual Drilling w/ KDM110 KEEP-NUT[™] Drilling Machine
Go/No-Go Hole Tester/Depth Gauge SKU: CCH-KNKSET-1/4		Tool used to check the diameter and depth of each drilled hole prior to pressing-in KEEP-NUT[™] (highly recommended when manually drilling)
Insertion/Setting Tool SKU: CCH-KNGAUGE		Insertion tool for KEEP-NUT[™] to deflect impact from mallet when pressing KEEP-NUT[™] into surface.

Full Sink Mounting Sets:

Full KEEP-NUT[™] Set SKU: CCH-KEEPNUT-1/4-KIT		All items needed for KEEP-NUT[™] Sink Anchors Including: <ul style="list-style-type: none"> • IM2S/P1.4-20/H6 KEEP-NUT[™] • 1 1/4" Length Post • Z-Shaped Sink Clip • Wingnut and Washer
Full KEEP-NUT[™] 100 pc Starter Set w/Tooling SKU: CCH-KEEPNUT-STRKIT 1		KEEP-NUT[™] 100 pc kit includes: <ul style="list-style-type: none"> • 100—IM2S/P1.4-20/H6 KEEP-NUT[™] • 100—1 1/4" Length Post • 100—Z-Shaped Sink Clip • 100—Wingnut and Washer • Drill Bit of Choice • Go-No-Go Hole Tester • Setting Tool
Full KEEP-NUT[™] 500 pc Starter Set w/Tooling SKU: CCH-KEEPNUT-STRKIT 5		KEEP-NUT[™] 500 pc kit includes: <ul style="list-style-type: none"> • 500—IM2S/P1.4-20/H6 KEEP-NUT[™] • 500—Z-Shaped Sink Clip • 500—IM2S/P1.4-20/H6 KEEP-NUT[™] • 500—Z-Shaped Sink Clip • Drill Bit of Choice • Go-No-Go Hole Tester • Setting Tool

See our complete line of **KEEP-NUT[™]** parts @ chemical-concepts.com

KEEP-NUT[™] Drilling Machine

KDM110 —KEEP-NUT[™] Drilling Machine w/Polisher

SKU: CCH-KN-KDM110
(Vacuum Drilling Machine w/Polisher)

SKU: CCH-KN-KDM50
(Vacuum Drill Stand Only)

SKU: CCH-KN-KDM680C
(Modified Alpha AIR-680 Polisher Only)

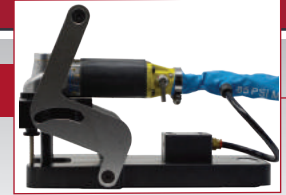

Use 11.8 drill bits only with
KEEP-NUT[™]
DRILLING MACHINE

- Fast, efficient drilling on hard surfaces
- Lightweight and easy to operate
- Built in depth stop for precise, repeatable results
- Vacuum-foot for secure attachment to rough or even vertical surfaces
- Drill holes in granite for sink install
- Water cooled and air-operated



1. Alpha High Performance Pneumatic Polisher used for Drilling, Wet Polishing and Profiling
2. 15 ft. Central Water Feed Hose, Water Inlet: 1/8" BSPP
3. 15 ft. Air Hose, Requires 85 PSI, Air Inlet: 1/4" BSPP
4. Vacuum Base for Precision & Vertical Drilling
5. 5/8-11 Thread Spindle with 11.4mm Manual **KEEP-NUT[™]** Drill Bit for **KEEP-NUT[™]** Drilling
6. Stopper for Precision Drill Depth



Supports up to 562 lbs. per anchor



Ventilated Facades



Under-mount Sink Anchor

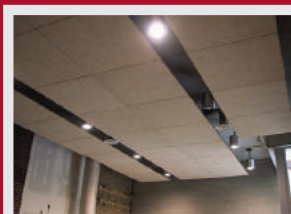

Panel and Ceiling Hanging

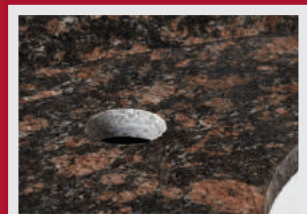

Faucet Hole Drilling

Bonding Fasteners

Chem-Set™ BONDING FASTENERS

Available in plated steel and stainless steel (plating meets European standards)
Available in stainless steel, aluminum or zinc plated

Chem-Set™ Bonding Fasteners allow you to create male or female threaded attachment points on porcelain surfaces without drilling into the material. The using our **Chem-Set™ 605** adhesive the bond is so strong, it often exceeds the strength of the steel fastener!

Adhesive Strength



Shows the strength of our **Chem-Set™ Bonding Fasteners** and our **605 Quick Set Acrylic** adhesive bonded to porcelain. After knocking it with a hammer, it will not fail!

Applications include undermount sinks, furniture, signage, desk hardware, and more...

Bond **PORCELAIN AND ENGINEERED STONE**



SKU: CCH-F1-T38



SKU: CCH-M1-B38



SKU: CCH-M1-B23

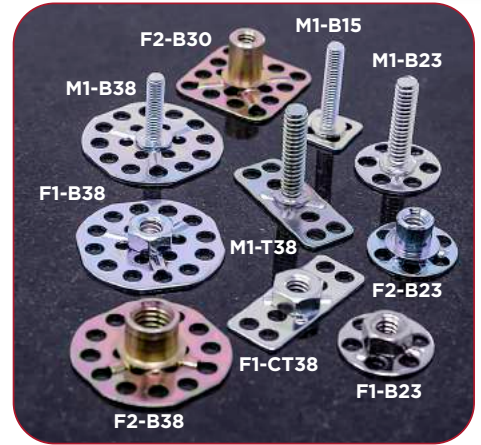

Chem-Set™ Z-Shaped Sink Clips



SKU: CCH-732G

• Sold in box of 100
(see adhesive below)

Galvanized Steel "Z" shape

Chem-Set™ C-Shaped Sink Clips



SKU: CCH-733G

• Sold in box of 100
(see adhesive below)

Galvanized Steel "C" shape

Chem-Set™ 730S Stamped Wingnuts



SKU: CCH-730S

• Sold in box of 100
(see adhesive below)

Chem-Set™ K-Lock Nuts



SKU: CCH-LOCKWASHERS

• 100 pcs. bagged



Sink clips and accessories used —
See each page for recommended gun to use with adhesive

Chem-Set™ 605 Quick Set Acrylic

Acrylic adhesive for use on Porcelain, Solid Surface, Engineered Stone, Plastics and Metals.

SKU: CCA605

Bonds **PORCELAIN AND ENGINEERED STONE**

WHITE/CLEAR



Available sizes:
25ml, 50ml
and 400ml

Seaming Adhesives

Chem-Set™ Color matches to ALL stone, engineered stone and Solid Surface colors

Chem-Set™	SEAMING ADHESIVE COLOR MATCH TOOL	C-20	C-30
		Color match to ALL stone and solid surface colors	
C-30 Marblemaster "Dripless" Seaming Adhesive			



Chem-Set™ C-30 'NO-DRIP' MARBLEMASTER SEAMING ADHESIVE

- Revolutionary seaming adhesive Designed for granite, marble, porcelain, sintered stone, glass, engineered stone, and natural stone products
- Drip-less 'Non-Sag' Acrylic Adhesive
- Designed for vertical applications, mitered edges and deck seams
- Saves time and improves results!

250 ml

SKU: CCA-C30-Color #

See color match on next page

Better Color Matches vs Epoxy



Chem-Set™ C-20 SEAMING ADHESIVE

- Seaming Adhesive for Quartz, Natural Stone, Solid Surface, Ceramic and more
- Eliminate Hand Mixing and Tinting
- Provides the strength and speed of an Epoxy Adhesive, along with the color stability of an Acrylic Adhesive
- Faster Gelling and Curing Times

250 ml

SKU: CCA-C20-Color #

See color match on next page

	Work Time	Color
Size	10-15 min.	See color chart on website
	150ml, 250ml and 500ml	
Gun	VR210 GUN 26:1 Ratio	 250 ml
	SKU: NEW-VR210XSP	
15 MINUTES AT ROOM TEMPERATURE		

SUGGESTED MIXERS



CON-MFQX-08-24T



CON-MFHX-08-18T



Cross match to hundreds of manufacturers to find your color fast!

See our complete line of seaming adhesive products @ chemical-concepts.com

Silicone Sealants

Chem-Set™ RTV3500 & RTV4500

Chem-Set™ RTV 4500 is a one component room temperature

vulcanizing (RTV) industrial/construction grade silicone sealant and adhesive that has been chemically formulated for high strength adhesion.



- High Strength
- Excellent Weatherability
- UV Stable
- Non-Yellowing
- VOC Compliant
- Non-Flammable
- Waterproof
- Excellent Adhesion
- Non-Shrinking

Chem-Set™ RTV3500

Available Colors:



Chem-Set™ RTV4500

Available Colors:

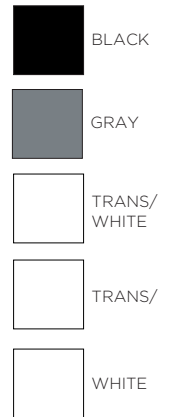

Bondaflex 100

TECHNOLOGIES

Bondaflex Sil 100 GP is a general purpose, one-component, non-sag, elastomeric, 100% RTV acetoxy silicone sealant.

- Ready to use, labor cost reduction
- Bonds to most substrates without priming
- Excellent flexibility for dynamic joint movement & dissimilar materials

Size	10.3 Cartridge
Gun & Mixer	NEW-250 Caulk Gun SKU: NEW-250
18:1 250 ml	 Silicone Nozzle 4" PK /12
Full cure 24 hours	

- Move assembled or sealed parts quickly
- Wide service temperature/durability
- Speed and ease of application
- Matches a variety of substrates

Bondaflex 100

TECHNOLOGIES

Available Colors:



Silicone / Sealants

Hybrid Sealants

Hybrids are silane-crosslinking organic polymers that combine properties typical of both silicone and polyurethane while eliminating their individual inherent weaknesses. Thus, hybrid sealants combine the adhesive strength and paintability of polyurethane with the weathering resistance of silicones.

“Silicone on Steroids”



ULTRA CLEAR

SKU: CCS-MS35-UC



WHITE

SKU: CCS-MS35-WT-100Z

Chem-Set™

MS-35 ULTRA CLEAR 24 tubes per case

Chem-Set™

MS-35 WHITE 24 tubes per case

- Recommended adhesive for bonding porcelain to tile backer board
- Available in 10.3 standard cartridge
- 2 times the bond strength of silicone - Lap shear 250-330 PSI
- 100% VOC HAPS/Compliant -75°F to 250°F (operating temp range)

	Color
	Ultra Clear/White
Size	10.3 Cartridge
Gun	250 GUN Thrust Caulk Gun 18:1 SKU: NEW-250 250 ml 
Cure	Skin over time: 20 minutes Tack time: 40 minutes

Siliconized Acrylic Latex



SKU: CCS-PB3

AVAILABLE COLORS:



SKU: CCS-PB3-CLEAR SKU: CCS-PB3-WHITE SKU: CCS-PB3-ALMOND

Chem-Set™ PB-3

- One-component, latex sealant
- Paintable, mildew resistant and non-yellowing
- Water clean up

	Color
	Clear, White, Almond
Size	10.3 Cartridge
Gun	250 GUN Thrust Caulk Gun 18:1 SKU: NEW-250 250 ml 
Cure	Skin over time: 30 minutes Tack time: 40 minutes

Polyurethane Construction Adhesive

 **Sikaflex 1A Construction Sealant**



AVAILABLE COLORS:



SKU: SIK91009-ALUMINUM GRAY
SKU: SIK91011-BLACK

SKU: SIK91017-WHITE
SKU: SIK91013-COLONIAL WHITE

SKU: SIK91016-CAPITAL TAN
SKU: SIK91014-DARK BRONZE

- Non-sag elastomeric sealant
- Excellent resistance to aging, weathering paintable
- Certified NSF/ANSI standard for potable water and jet fuel resistant
- High elasticity

	Color
	Aluminum Gray, Black, Capital Tan, Colonial White, Dark Bronze, Limestone, Medium Bronze, White
Size	10.3 Cartridge
Gun	250 GUN Thrust Caulk Gun 18:1 SKU: NEW-250 250 ml 
Cure	Tack time: 3 hours

See our complete line of adhesive sealants @ chemical-concepts.com

Porcelain Scratch Repair

Surface Renu™ Porcelain Scratch Repair Kit

SurfaceRenu™ offers a full line of products for the removal of scratches, and damage from most types of polished ceramic surfaces.

SurfaceRenu is the industry's premier solution for rapid scratch removal from polished ceramic without leaving trace marks or creating distortion. Our Professional Grade System is designed to repair the most common types of ceramic damage, by providing the operator a simple, effective way to quickly restore damaged ceramic to "like-new" condition. The system features simple-to-follow instructions and everything required except a sander/polisher.

Every Professional Grade System includes high quality and reliable components, offering unparalleled speed and success in repairing damaged ceramic.

RenuDisks®

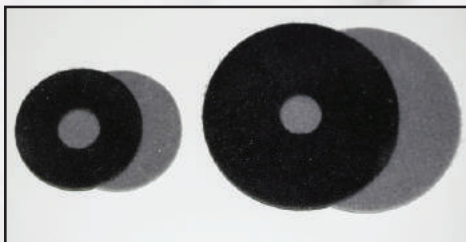

RenuDisks are available in two sizes (3" and 5") in two grinding ranges to match the type of surface damage being repaired.

The patented design and construction are proprietary to SurfaceRenu and available only through SurfaceRenu and Authorized SurfaceRenu Resellers. The disks employ a special construction that allows for rapid scratch removal from polished ceramic without leaving trace marks or discernible distortion — even on deep damage.

Instructions on when to use a particular disk size or grinding range are included with every SurfaceRenu System. The disks are color-coded for quick identification and ease of use. Selection by color helps to take the guesswork out of the scratch removal process.

RenuDisk Grinding Range Color Key:

- BLACK** Used for all damage that catches a fingernail
- GREY** Used to remove damage you can't feel with your fingernail and for Pre-polish



The SurfaceRenu Professional Grade System is a complete solution and includes:

- High-end custom made backing pads—3" & 5"
- 2ct 5" Polishing felts
- Rasp file
- 40 RenuDisks®
- 1—bottle of Light & Dark Polish Compound
- Dust mask
- Easy to follow instructions

Surface Renu Polishing Compound

Each Professional Grade System comes with a bottle of SurfaceRenu's proprietary advanced formula Polishing Compound. We take rare earth mineral polish to a whole new level by refining and milling our own blend of polishing compounds to achieve the highest quality surface finish. One bottle of polish, filled with clean water to the top, will allow the user to polish up to 400 square feet of light damage from the ceramic surface.



• For Shop Use or Retail



See our complete line of SurfaceRenu™ products @ chemical-concepts.com

CounterBalance® Half Wall Overhangs



CounterBalance® COUNTERPLATE PLUS

Material	High Strength Steel (HRPO Steel*)
Overhang Support	15" Supports 18" overhangs 12" Supports 15" overhangs
Mounting Holes	3 Mounting Holes
Width	2 ½" (63.5 mm)
Length	15" (381 mm) 12" (303.8 mm)
Thickness	7 GA



CounterBalance® COUNTERPLATE

Material	High Strength Steel (HRPO Steel*)
Overhang Support	Supports 13" overhangs
Mounting Holes	3 Mounting Holes
Width	3 ¾" (95.25 mm)
Length	9 ¾" (247.7 mm)
Thickness	7 GA



CounterBalance® COUNTERPLATE XL

Material	High Strength Steel (HRPO Steel*)
Overhang Support	Supports 15" overhangs
Mounting Holes	3 Mounting Holes
Width	3 ¾" (95.25 mm)
Length	11 ¾" (298.5 mm)
Thickness	7 GA

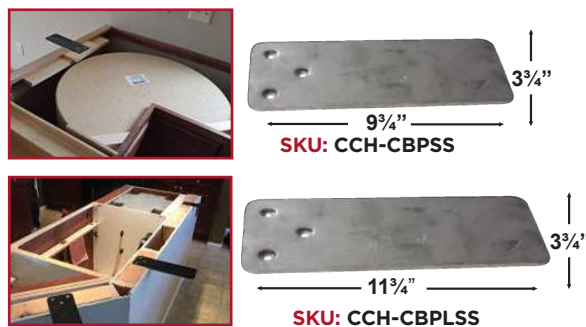

STAINLESS STEEL COUNTERPLATE & CounterBalance® COUNTERPLATE XL

Material	304 stainless steel
Overhang Support	Supports 13" & 15" overhangs
Mounting Holes	3 Mounting Holes
Width	3 ¾" (95.25 mm)
Length	9 ¾" (247.7 mm) & 11 ¾" (298.5 mm)
Thickness	7 GA

See our complete line of CounterBalance® products @ chemical-concepts.com

CounterBalance® Half Wall Overhangs

POWDER COATED

SKU: CCH-CBCP

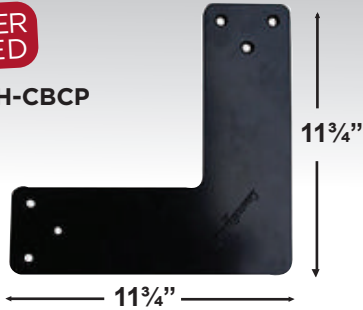

CounterBalance® CORNERPLATE

Material	High Strength Steel (HRPO Steel*)
Overhang Support	Supports 15" forward overhangs 13" one side
Mounting Holes	3 Mounting Holes
Width	3 3/4" (95.25 mm)
Length	11 3/4" (298.5 mm)
Thickness	7 GA

Cabinetry Overhangs



POWDER COATED

SKU: CCH-CBIB2

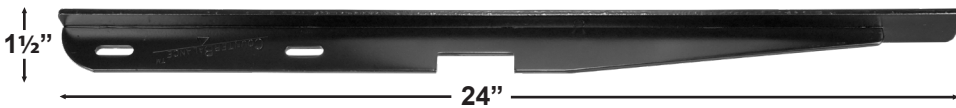

- Corners are rounded for safety
- Available in kits of 3

CounterBalance® ISLANDBAR (24")

Material	High Strength Steel (HRPO Steel*)
Overhang Support	Supports 18" overhangs
Mounting Holes	2 Mounting Holes
Width	1 1/2" (38.1 mm)
Height	1 1/2" (38.1 mm)
Length	24" (610 mm) long
Thickness	7 GA



SKU: CCH-CBIBM

POWDER COATED



CounterBalance® ISLANDBAR MINI (20")

Material	High Strength Steel (HRPO Steel*)
Overhang Support	Supports 15" overhangs
Mounting Holes	2 Mounting Holes
Width	1 1/2" (38.1 mm)
Height	1 1/2" (38.1 mm)
Length	20" (508 mm) long
Thickness	7 GA

CounterBalance[®] Cabinetry Overhangs

POWDER COATED

SKU: CCH-CBXB2

AVAILABLE COLOR:  Black



CounterBalance[®] CROSSBAR (24" x 24")

Material	High Strength Steel (HRPO Steel*)
Overhang Support	Supports 18" overhangs
Mounting Holes	2 Mounting Holes
Width	1 1/2" (38.1 mm)
Height	1 1/2" (38.1 mm)
Length	24" x 24" length (610 mm x 610 mm)
Thickness	7 GA

POWDER COATED

SKU: CCH-CBXB2

AVAILABLE COLOR:  Black



CounterBalance[®] CROSSBAR MINI (18" x 18")

Material	High Strength Steel (HRPO Steel*)
Overhang Support	Supports 15" overhangs
Countersink Holes	2 Mounting Holes
Width	1 1/2" (38.1 mm)
Height	1 1/2" (38.1 mm)
Length	18" x 18" length (457.2 mm x 457.2 mm)
Thickness	7 GA



See our complete line of **CounterBalance[®]** products @ chemical-concepts.com

CounterBalance® Cabinetry Overhangs



CounterBalance® CONCEALED BRACKETS

- Low-profile brackets provide a clean, “floating” look for your countertop
- Available lengths: 9”, 12”, 18”, and 24”
- Supports should be placed every 16” to 20”
- Available colors: white, black, grey and almond

SKU: CCH-CBCB

AVAILABLE COLORS:



White, Black, Grey and Almond

Pictured: 18”



CounterBalance® CONCEALED EXTENDED BRACKETS

- Low-profile brackets provide a clean, “floating” look for your countertop
- Available lengths: 9”, 12”, 18”, and 24”
- Supports should be placed every 16” to 20”
- Available colors: white, black, grey and almond

SKU: CCH-CBECB

AVAILABLE COLORS:



White, Black, Grey and Almond

Pictured: 9”



CounterBalance® CONCEALED FLAT BRACKETS

- Load limit range of 1400 lbs to 4900 lbs per pair
- Mounting hardware included
- Available lengths: 9”, 12”, 18”, and 24”
- Supports should be placed every 16” to 20”
- Available colors: white, black

SKU: CCH-CBCFLAT

AVAILABLE COLORS:



White and Black

Pictured: 24”



CounterBalance® EXTENDED CONCEALED FLAT BRACKETS

- Upper extension (above the support arm) provides superior strength
- Load limit range of 1400 lbs to 4900 lbs per pair
- Mounting hardware included
- Available lengths: 9”, 12”, 18”, and 24”
- Supports should be placed every 16” to 20”
- Available colors: white, black

SKU: CCH-CBCEFLAT

AVAILABLE COLORS:



White and Black

Pictured: 24”

See our complete line of **CounterBalance®** products @ chemical-concepts.com

CounterBalance® Cabinetry Overhangs

CounterBalance® WORKSTATION BRACKETS



- Handicap accessible vanities and workstations
- Stone and solid surface
- Weight Bearing Shelving
- 1/8" steel construction
- Very strong - exceeds - 1,000 lbs load limit
- 1 1/2" mounting surface with multiple 1/4" holes per side
- Standard color textured powder coat finishes

AVAILABLE COLORS:



Black, White, Gray, Almond, Stainless Steel and Pre-primed for your own finish



SKU: CCH-CBADA

Black, White, Stainless Steel

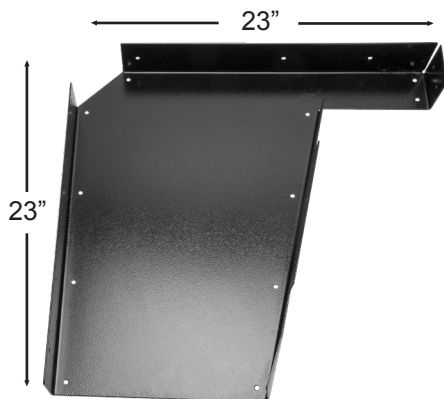

CounterBalance® ADA VANITY BRACKETS

- 12 Gauge Steel offers superior strength
- Optional mounting holes on sides of Black Brackets to install your finishing panel if desired
- Accommodates 22" to 26" deep countertops
- No visible fasteners
- No tools required to remove & reinstall skirt
- Mounting holes provided
- 3x3 cut out for wall cleat & wire run clearance
- Standard color textured powder coat finishes: Black, white, gray, stainless steel and pre-primed for your own finish

- 21" length 533.4mm
- 22" height 558.8mm
- 3" width 76.2mm

- 23" length 584.2mm
- 22" height 558.8mm
- 3" width 76.2mm

- Available in the US or Import

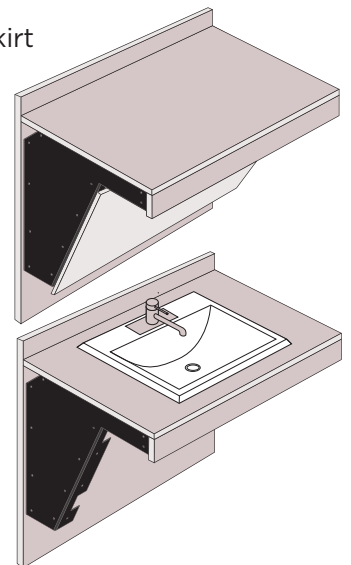

See our complete line of **CounterBalance®** products @ chemical-concepts.com

CounterBalance® Suspended Overhangs



- 1.0" or 1.5" T and 9", 12", 18", and 24" support arms
- Load limit range of 525 lbs. to 2,200 lbs. per pair
- Available in black and white powder coat

SKU: CCH-CBHYB



CounterBalance® HYBRID BRACKET

Width	1" or 1 ½" (38.1 mm)
Height	1 ½" (38.1 mm)
Length	18" x 18" & 18" x 24" lengths

- Finishing caps provided

CounterBalance® HEAVY DUTY HYBRID BRACKET

Width	3" (72 mm)
Height	1" (24 mm)
Length	18" x 18" & 24" x 24" lengths

- Recommended double stud for bracket attachment
- Brackets available in black and white powder coat
- Available with 18" or 24" support arm
- 18" tall x 18" projection x 3" wide and 24" tall x 24" projection x 3" wide
- 1700 lbs./pr 18", 1350 lbs. /pr 24"
- Packed: 2 Per Box
- Finishing caps provided



AVAILABLE COLORS:
White and Black

SKU: CCH-CBHDHYB



CounterBalance® FLOATING VANITY BRACKETS

Material	.25" Steel—Extremely Strong
Overhang Support	Supports 18" overhangs
Load limit	1100 lb load limit
Tall	2" (50.8 mm)
Wide	28" (711.2 mm)
Projection	18" (457.2 mm) arm projection

- Blocking across back plate recommended
- 1 pc/21 lbs

See our complete line of **CounterBalance®** products @ chemical-concepts.com

CounterBalance® Suspended Overhangs

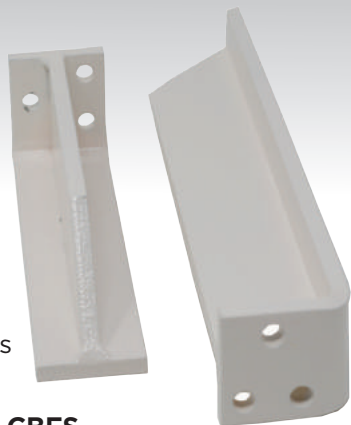

*sold in pairs

SKU: CCH-CBFS

AVAILABLE COLOR: White

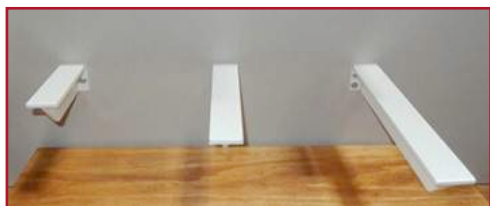

SKU#’s for available sizes:

SKU: CCH-CBFS6-IM 2 pc/3 lbs

SKU: CCH-CBFS9-IM 2 pc/4 lbs

SKU: CCH-CBFS6-IM 2 pc/5 lbs

FLOATING SHELF BRACKETS

CounterBalance®

Material	.25" Steel—Extremely Strong
Tall	1 ¾" (44.45 mm)
Thickness	.25" thick (6.35 mm)
Wide	1 ½" (38.1 mm)
Length	6", 9" and 12" lengths

- **Load Limit:** 2000 lbs/pr 6", 1500 lbs/pr 9" and 1000 lbs/pr 12"
- Brackets must be mounted directly to the stud for maximum strength
- Mounting hardware will fail before bracket
- Brackets can be hidden in a boxed shelf

HIDDEN SHELF BRACKETS

CounterBalance®



SKU: CCH-CBHS

AVAILABLE COLOR: White



Material	.25" Steel—Extremely Strong
Tall	1 ½" (38.1 mm)
Thickness	.25" thick (6.35 mm)
Wide	20" (508 mm)
Length	6", 9" and 12" lengths

- **Load Limit:** 450 lbs/pr 6", 400 lbs/pr 9" and 350 lbs/pr 12"
- Blocking across back plate recommended
- Brackets can be hidden in a boxed shelf

SKU#’s for available sizes:

SKU: CCH-CBHS6 1 pc/5 lbs

SKU: CCH-CBHS9 1 pc/7 lbs

SKU: CCH-CBHS12 1 pc/8 lbs

See our complete line of CounterBalance® products @ chemical-concepts.com

Tape and Surface Protection Film

Chem-Set™ Blue Painters Tape

The environmentally safe painter's tape will cleanly remove from most surfaces for up to 21 days, leaving clean, crisp paint lines.

SKU: CCT-P621

- Comes in sizes from 3/4" to 3"
- Works on a variety of surfaces
- Designed to prevent dry out or keep its holding power

60 YD ROLLS

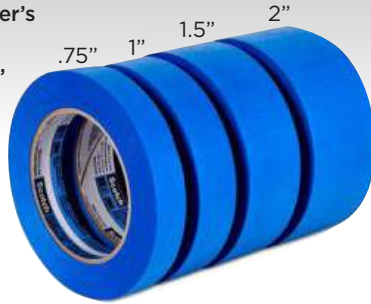

Alpha G-Tape

G-Tape is a patented combination of solvent acrylic adhesive with an advanced backing substrate that results in unmatched performance.

SKU: CCT-G-TAPE

- Waterproof
- Repositionable
- Great for quick repairs
- Hard surface protection
- Weather and UV resistant
- 2" X 163' (60 yds) multi-purpose tape
- Hand tears, straight and easy

60 YD ROLLS



Chem-Set™ Masking Tape 5.0 mil

This all purpose masking is primarily used for general purpose bundling, packaging, protecting, and splicing.

SKU: CCT-P217

- Coated with natural rubber adhesive
- Excellent adhesive
- Temperature resistant
- Cream color

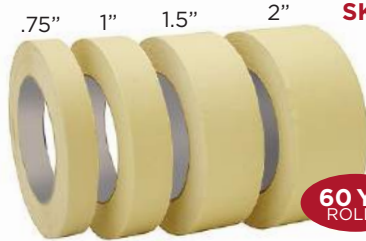

60 YD ROLLS

Chem-Set™ Poly Film Mitre Tape

This 7 mil tape is excellent for mitring offering the perfect combination of strength and durability.

SKU: CCT-P74-2C

- Use for mitring
- 7 mil. Clear
- Size 2" X 60'



tesa® Precision Mask

tesa® 4334 3.5 mil (.0035")

SKU: TES-4334

The tesa Precision Mask 4334 reliably guarantees razor-sharp paint edges, and is extremely easy to use

- Yellow precision masking tape
- Suitable for precise applications
- Guarantees very sharp-edged finishing
- Suitable for delicate surface

55 YD ROLLS

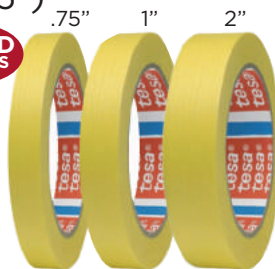

Chem-Set™ 3.0 & 4.0 mil Surface Protection Film

SKU PRES30L40

medium/high tack, 3 mil thick 24" x 600'

SKU PRES30L40-30

medium/high tack, 3 mil thick 30" x 600'

- Protect counters and porcelain/marble and granite pieces from damage during storage construction, and transportation
- Can be safely applied to the surface without damaging the counter or leaving residue
- Good for use on flat surfaces

600 Foot Rolls

Available Sizes
Film 24" x 600' • 30" x 600'



Chem-Set™ Foil Tape 3.0 mil

Aluminum Foil/Acrylic Adhesive

SKU: CCT-AF30SW-2

- Surface film protection
- Used for waterproofing, vapor barrier, and air leakage protection
- High reflectivity assures effective heat, light interference, and electrical insulation shielding
- Designed to stick firmly to it's own backing
- Great for installing cook tops in solid surface
- Premier product for masking in paint stripping and electroplating

60 YD ROLLS



See our complete line of Chem-set™ tapes @ chemical-concepts.com



410 Pike Road • Huntingdon Valley, PA 19006

TOLL FREE: 800.220.1966

Phone: 267.684.1038 • Fax: 215.357.2754 • Email: sales@chemical-concepts.com

chemical-concepts.com